

Modern Ag Parts - Beaumont, Texas - Order Toll-Free 1-888-404-8908 - Fax Toll-Free 1-888-404-8910

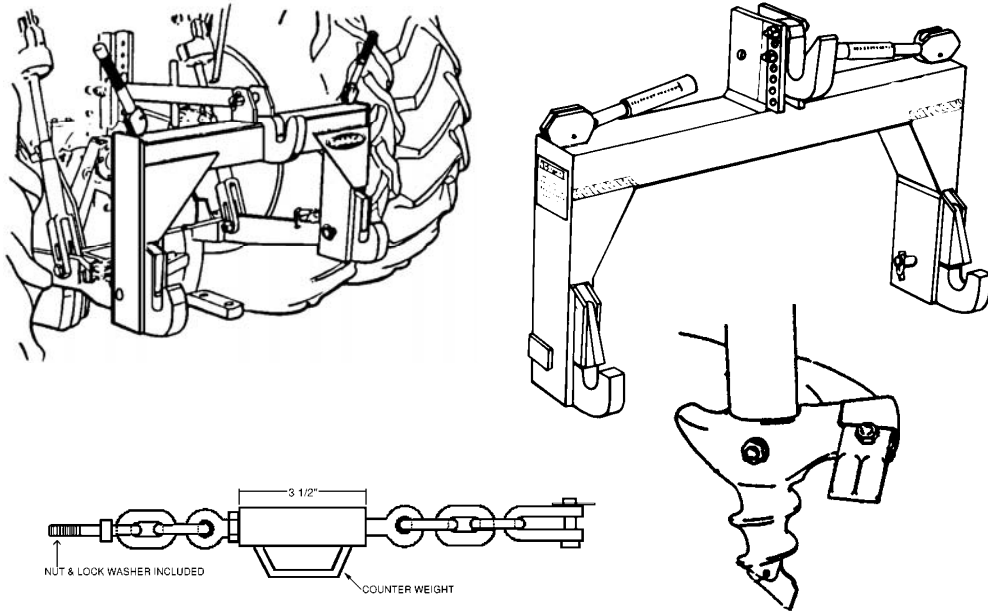

## 3 PT. & TRACTOR ACCESSORIES SECTION

# Modern Ag Parts

Modern Ag Parts - Beaumont, Texas - Order Toll-Free 1-888-404-8908 - Fax Toll-Free 1-888-404-8910

## QUICK HITCHES

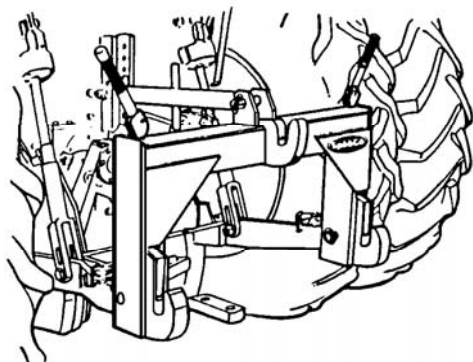

- For fast, easy attachment and release of 3-Point implements.
- Safe - Operator can engage and secure implement from the tractor seat. Reduces chance of strained back, smashed fingers, or other injuries associated with implement hookup.
- Models to fit most Category 1, 2, and 3 tractors.
- Heavy duty steel construction, utilizing heavy steel plate material for lifting claws.

PART NO.	MFG. NO.	DESCRIPTION	WEIGHT	MAX. HORSEPOWE
162-1	HF141101	Fits most Category 1 tractors. For use with Category 1 equipment. Adjustable top link ball bracket on Category 1 only. Includes 7/8" mounting pins and adapter bushing. 26" width.	76	50
162-3	HF141107	Category 2 Heavy Duty Quick Hitch . Complete with 1-1/8" mounting pins and adapter bushing. 32" width	160	150
162-4	HF141103	Category 3 Quick Hitch designed to fit most Category 3 tractors pulling Category 3 equipment. Complete with 1-7/16" mounting pins. 38" width.	182	225
BUSHING ADAPTERS & HANDLE				
162-206	HF141144	Bushing adapter kit. Complete with roll pins & bushing for Cat. 1 Hitch.	N/A	N/A
162-200	HF141130	Bushing adapter kit. Complete with roll pins & bushing for Cat. 2 Hitch.	N/A	N/A
162-251	HF141133	Replacement handle for Cat. 2 & 3 hitches	N/A	N/A

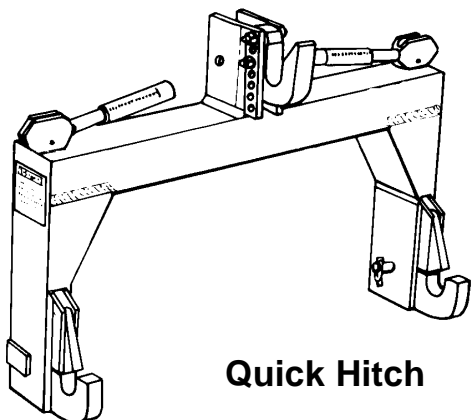

Quick Hitch

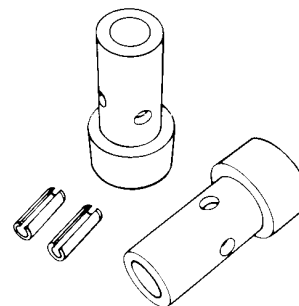

Bushing Adapters

Modern Ag Parts - Beaumont, Texas - Order Toll-Free 1-888-404-8908 - Fax Toll-Free 1-888-404-8910

## 3-POINT HITCH ACCESSORIES AND REPAIR PARTS

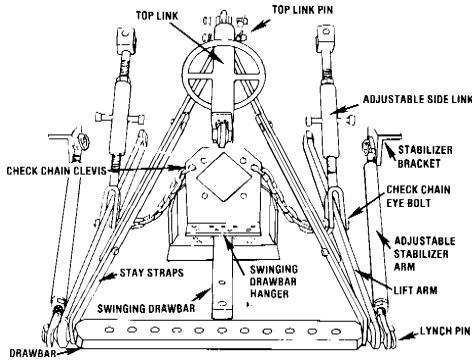

### DEFINITIONS

CATEGORY 1, 2, 3, AND 4 ARE USED TO CLASSIFY TRACTORS BY DRAWBAR HORSEPOWER. THE TABLE BELOW GIVES THE DIMENSIONS AND THE HORSEPOWER RATING THAT ARE ASSOCIATED WITH THESE FOUR CATEGORIES.

MAXIMUM DRAWBAR HORSEPOWER	TOP LINK PIN DIAMETER	PULL OR DRAW PIN DIAMETER	STANDARD LIFT ARM SPACING
CAT. 0-UP TO 20	5/8 IN. (16MM)	5/8 IN. (16MM)	20 IN. (508MM)
CAT. 1-UP TO 45	3/4 IN. (19MM)	7/8 IN. (22MM)	26 IN. (660MM)
CAT. 2-40 TO 100	1 IN. (29MM)	1 1/8 IN. (29MM)	32 IN. (813MM)
CAT. 3-80 TO 225	1 1/4 IN. (32MM)	1 7/16 IN. (36MM)	38 IN. (965MM)
CAT. 4-135 TO 300	2 IN. (51MM)	1 3/4 IN. (44MM)	46 IN. (1168MM)

**SPEEBALLS** : THE TRADEMARK FOR BALL SOCKETS THAT ARE DRILLED FOR TWO DIFFERENT PIN DIAMETERS.

## HYDRAULIC TOP LINK CYLINDER

THE TOP LINK CYLINDER ALLOWS FOR CONTROL OF TOP LINK ADJUSTMENT FROM THE TRACTOR SEAT. FITS MOST CAT. II TRACTORS AND IMPLEMENTS. IDEAL FOR BALE MOVERS, BLADES, POST DRIVERS AND QUICK HITCHES.



### SPECIFICATIONS

- 3" BORE, 10" STROKE
- 20-1/2" CLOSED DIMENSION
- 1-1/8" HARD CHROME PLATED ROD
- 1/2" NPT PORTS
- 3000 P.S.I. OPERATING PRESSURE
- 1" PIN OPENINGS ON BOTH ENDS

PART NO.	DESCRIPTION
260-188	Toplink Cylinder
260-189	Seal Kit

## O.E.M. TOP LINK ASSEMBLIES

### CAT. 1 FORD

FORGED WITH FOLD AWAY  
 ADJUSTMENT HANDLE 16-3/4" BODY

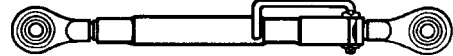

Fits 4000 thru 7000 1971 & up 3/4" PIN HOLES, 1/4" DIA. THREAD  
 Replaces D0NN576B ADJUST FROM 24-1/2" TO 34-1/2"

**PART NO.**  
 159-10202

### CAT. 1 & 2 FORD

FORGED WITH FOLD AWAY  
 ADJUSTMENT HANDLE 16-3/4" BODY

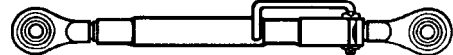

Fits 4000 thru 7000 1971 & up 3/4" & 1" PIN HOLES, 1/4" DIA. THREAD  
 Replaces E6NN576C ADJUST FROM 24-1/2" TO 34-1/2"

**PART NO.**  
 159-10200

### CAT. 2 FORD

FORGED WITH FOLD AWAY  
 ADJUSTMENT HANDLE 16-3/4" BODY

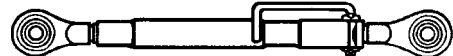

Fits 4000 thru 7000 1971 & up 1" PIN HOLES, 1/4" DIA. THREAD  
 Replaces D0NN576A ADJUST FROM 24-3/4" TO 34-3/4"

**PART NO.**  
 159-10201

### CAT. II IHC

Fits 786, 886, 986, & 3088, 3288,  
 3488, 3688, w/ Cat.II lateral type hitch

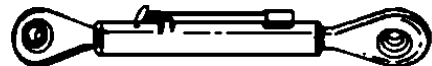

**PART NO.** 853-4805 **WT.** 18 lbs.

### CAT. III IHC

Fits 1066 & 1466 Hitch, 1566 Above S/N 11256, 1568 Above S/N  
 7809, 1086, 1486, 1586, 3388, 3588, 3788, 5088, 5288, 5488,  
 6388, 6588, 6788, & 3288, 3488, 3688, W/ Cat. III Hitch Cam  
 Limiter Type.



**PART NO.** 853-4804 **WT.** 26 lbs.

Modern Ag Parts - Beaumont, Texas - Order Toll-Free 1-888-404-8908 - Fax Toll-Free 1-888-404-8910

## O.E.M. TOP LINK ASSEMBLIES

### CAT. II JOHN DEERE

Fits 2510, 2520, 4030

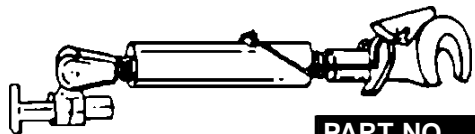

PART NO.	WT.
854-4804	20 lbs.

### CAT. III JOHN DEERE

Fits 4630, 4640, 4650, 4840, 4850, 8440, 8450,  
8630, 8640, 8650



PART NO.	WT.
854-4805	25 lbs.

### CAT. 1 & 2 JOHN DEERE

For models: 1030, 1040, 1130, 1140, 1630, 1640,  
2030, 2040, 2130, 2140 & 3030.

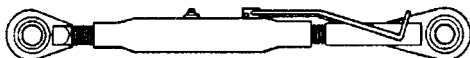

Forged toplink with  
latch, painted green.

PART NO.
159-25101

12-1/2" center tube  
3/4" & 1" PIN HOLES, 1-1/8" DIA.  
THREAD ADJUSTS FROM 21-5/8" TO 30"

### CAT. 2 JOHN DEERE

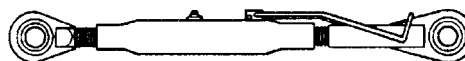

Forged toplink with latch,  
painted green.

PART NO.
159-25102

12-1/2" center tube  
1" PIN HOLES, 1-1/8" DIA. THREAD  
ADJUSTS FROM 21-5/8" TO 30"

### MASSEY FERGUSON

Forged toplinks with latch.



PART NO.	REPLACES	CATEGORY	CENTER TUBE
159-15200	677198	1	21-1/2"
159-15201	1870075M1	1	17-1/4"
159-15202	677197	1	18-3/4"
*159-15203	894376M1	1 & 2	18-3/4"
159-15204	893478M1	2	18-3/4"
*159-15205	894377M1	1 & 2	21-1/2"
159-15206	19876A91	2	21-1/2"

\*LH IMPLEMENT END CAT. 1, RH TRACTOR END CAT. 2 21-1/2"

# QUALITY & MODERN:

## OUR PERSONAL COMMITMENT

Providing Customer Satisfaction,  
Competitive Prices, Quality Products  
And Service You Can Rely Upon Since 1963.

Modern Ag Parts - Beaumont, Texas - Order Toll-Free 1-888-404-8908 - Fax Toll-Free 1-888-404-8910

## ADJUSTABLE TOP LINKS CATEGORY 0

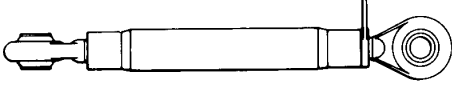
<b>PART NO.</b> 159-96	<b>MFG. NO.</b> TL-199		<b>FORGED 7 1/2" BODY</b>  5/8" PIN HOLES, 3/4" DIA. THREAD ADJUST FROM 11" TO 16"
---------------------------	---------------------------	---	---

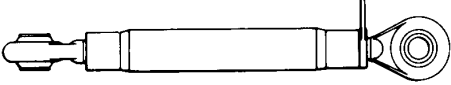
<b>PART NO.</b> 159-97			<b>FORGED 9 3/4" BODY</b>  5/8" PIN HOLES, 3/4" DIA. THREAD
---------------------------	--	---	---

## CATEGORY 1

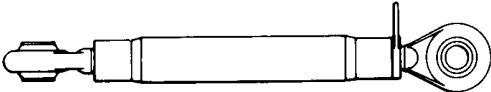
<b>PART NO.</b> 159-118			<b>FORGED 9" BODY</b>  3/4" PIN HOLES, 1-1/8 DIA. THREAD
----------------------------	--	---	--

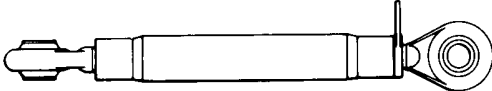
<b>PART NO.</b> 159-119			<b>FORGED 11" BODY</b>  3/4" PIN HOLES, 1-1/8 DIA. THREAD
----------------------------	--	---	---

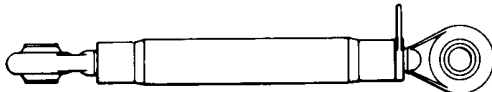
<b>PART NO.</b> 159-115			<b>FORGED 12.5" BODY</b>  3/4" PIN HOLES, 1-1/8 DIA. THREAD ADJUSTS FROM 17" TO 26-1/2"
----------------------------	--	---	--

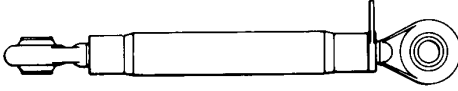
<b>PART NO.</b> TL-165			<b>FORGED 16" BODY</b>  3/4" PIN HOLES, 1-1/8" DIA. THREAD ADJUSTS FROM 20-1/2" TO 29"
---------------------------	--	---	---

**PLATED**  
**PART NO.**  
159-116

**RED**  
**PART NO.**  
159-120

**BLUE**  
**PART NO.**  
159-121

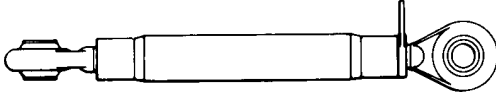
<b>PART NO.</b> 159-117	<b>MFG. NO.</b> TL-166		<b>FORGED 20" BODY</b>  3/4" PIN HOLES, 1-1/8" DIA. THREAD ADJUSTS FROM 24-1/2" TO 33"
----------------------------	---------------------------	---	---

**3 PT. & TRACTOR ACCESSORIES**

Adjustable Top Links  
 Forged Top Link Repair Ends  
 Top Link Weld on Ends, Top Link Thread Lock

Modern Ag Parts - Beaumont, Texas - Order Toll-Free 1-888-404-8908 - Fax Toll-Free 1-888-404-8910

## ADJUSTABLE TOP LINKS

### CATEGORY 2

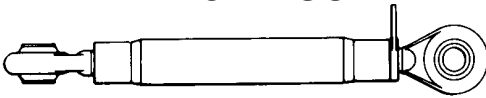
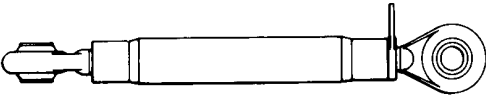
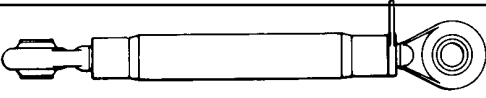
<b>PART NO.</b> 159-201	<b>MFG. NO.</b> TL-174		<b>FORGED 16" BODY</b> 1" PIN HOLES, 1-1/8" DIA. THREAD ADJUSTS FROM 21" - 33"
<b>PART NO.</b> 159-202	<b>MFG. NO.</b> TL-337		<b>FORGED 20" BODY</b> 1" PIN HOLES, 1-1/8" DIA. THREAD ADJUSTS FROM 25" - 37"
<b>PART NO.</b> 159-203	<b>MFG. NO.</b> ---		<b>FORGED 24" BODY</b> 1" PIN HOLES, 1-1/8" DIA. THREAD ADJUSTS FROM 29" - 41"

### CATEGORY 3

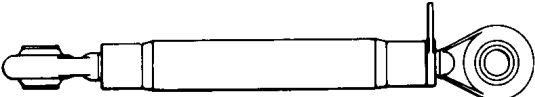
<b>PART NO.</b> 159-301	<b>MFG. NO.</b> TL-185		<b>FORGED 19" BODY</b> 1-1/4" PIN HOLES, 1-3/8" THREAD ADJUSTS FROM 25-1/2" - 36-1/2"
----------------------------	---------------------------	--	---

## FORGED TOP LINK REPAIR ENDS

### CATEGORY 1

PART NO.	DESCRIPTION	
159-1160 (LH) FORGED	1-1/8" NC THREADS 3/4" PIN HOLES	
159-1161 (RH) FORGED	1-1/8" NC THREADS 3/4" PIN HOLES	

### CATEGORY 2

159-2010 (LH) FORGED	1-1/8" NC THREADS 1" PIN HOLES
159-2011 (RH) FORGED	1-1/8" NC THREADS 1" PIN HOLES

## TOP LINK WELD ON ENDS

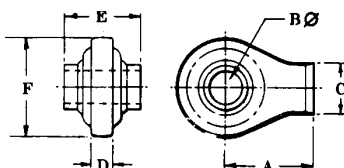

PART NO.	CAT.	A	B	C	D	E	F
159-101	1	2	3/4	1-1/8	1/2	1-3/4	2-1/4
159-102	2	2-3/8	1	1-1/8	1/2	2	2-5/8

## TOP LINK THREAD LOCK

### PART NO. 159-1513

TOP LINK LOCK - 1" NC RIGHT HAND THREADS FITS ALL  
 TOP LINKS WITH 1" NC THREADS

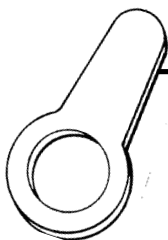

### PART NO. 159-1556

TOP LINK LOCK 1 1/8" NC RIGHT HAND THREADS FITS ALL  
 TOP LINKS WITH 1 1/8" NC THREADS

Modern Ag Parts - Beaumont, Texas - Order Toll-Free 1-888-404-8908 - Fax Toll-Free 1-888-404-8910

# Bulldog Ratchet Jack

Bulldog strength and durability puts this tough and trusted Ratchet Jack ahead of the rest. Every working part is manufactured using the highest quality assurance standards. Each engineering detail is designed for maximum strength and functionality. Every surface is protected against wear and weather. Put it all together and you've got a jack you can depend on for years of trouble-free service.



**Ratchet Jacks for:**

- Load bearing and lifting
- Three point hitch elevation
- Wheel extension and retraction
- Height adjustment
- Implement leveling

**Outperform the Competition:**

- 16,000 pounds pull (tension)
- 10,000 pounds push (compression)
- Stainless steel flat ratchet spring tested to 20 times the competition's life
- 3/8" U brackets tested to the endurance limit specified by a major OEM. Exceeds competition life by a factor of six.
- 20" retracted, 28" extended

**Ratchet Jack**

- Painted outer tube (black)
- Hexagonal jam nut
- 3/8" thick yellow zinc plated U brackets
- Stainless steel flat spring
- 2- 1" diameter pins with clips included
- 2 zerk fittings
- Yellow zinc dichromate plated 12" handle and cotter pin included
- Reinforced steel assembly housing with user friendly pawl
- 1-1/8" - 5 yellow zinc dichromate plated Acme screws

PART NO.	CAPACITY (LBS)	TRAVEL	REMARKS
159-1542	16,000 Pull 10,000 Push	8 Inches	"U" Bracket Style Ratchet Jack. 12" Handle. Includes Pins & Clips: 20" retracted, 28" extended

## ECONOMY RATCHET JACK

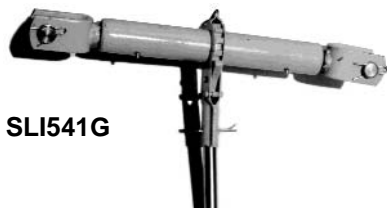

SLI541G

**PART NO.**  
159-1541

REPLACES MOST STANDARD HYDRAULIC CYLINDERS  
 ADJUSTS FROM 20" CLOSED TO 28" OPEN. SAFETY  
 DESIGN PREVENTS ENDS FROM BEING ACCIDENTALLY  
 THREADED OUT OF BODY. 1 1/4" NC THREADS. 1" CLEVIS  
 PINS, CLIPS AND HANDLE INCLUDED PAINTED YELLOW

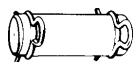

**PART NO.**  
150-7712

**DESCRIPTION**  
1" PIN FOR 159-1541  
RACHET JACK  
**RATING**  
15000 Pull  
10000 Push



**PART NO.**  
150-7910

**DESCRIPTION**  
PIN CLIP FOR 150-7712 PIN

Modern Ag Parts - Beaumont, Texas - Order Toll-Free 1-888-404-8908 - Fax Toll-Free 1-888-404-8910

## DRAWBARS

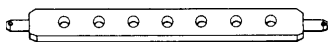

**DB418**

**PART NO.**

159-418

### CATEGORY 0

#### HEAT TREATED, 7 HOLE DRAWBAR-CATEGORY 0

FITS ALL TRACTORS WITH 20" LIFT ARM SPACING AND 5/8" BALL SOCKETS. MADE OF 5/8" X 2" HEAT TREATED HIGH CARBON STEEL; 20" LONG; 5/8" END PINS; 5/8" HITCH PIN HOLES. PAINTED RED WEIGHT:7 LBS.

**DB411**

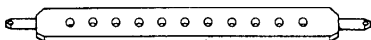

**RED**

**PART NO.**

159-411

**BLUE**

**PART NO.**

159-412

**DB419**

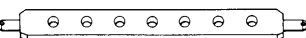

**PART NO.**

159-419

### CATEGORY 1

#### STANDARD 11 HOLE DRAWBAR-CATEGORY 1

FITS ALL TRACTORS WITH 20" LIFT ARM SPACING & 7/8" BALL SOCKETS. MADE OF 1" X 2 1/2" HIGH CARBON STEEL; 26" LONG; 7/8" END PINS; 3/4" HITCH PIN HOLES. PAINTED RED OR BLUE WEIGHT:17 LBS.

#### HEAT TREATED, 7 HOLE DRAWBAR-CATEGORY 1

FITS ALL TRACTORS WITH 20" LIFT ARM SPACING AND 7/8" BALL SOCKETS. MADE OF 1" X 2 1/2" HEAT TREATED HIGH CARBON STEEL; 20" LONG; 7/8" END PINS; 3/4" HITCH PIN HOLES. PAINTED BLACK WEIGHT:14 LBS. FITS KUBOTA, SATOH, YAMMAR, MITSUBISHI, AND IMPORTED MODELS FOR FORD, MF, DEERE ANDIH.

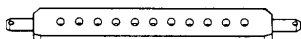

**DB421**

**PART NO.**

159-421

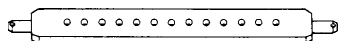

**DB422**

**PART NO.**

159-422

### CATEGORY 2

#### HEAT TREATED, 11 HOLE DRAWBAR-CATEGORY 2

FITS ALL TRACTORS WITH 26" LIFT ARM SPACING AND 1 1/8" BALL SOCKETS. MADE OF 1 1/4" X 3" HEAT TREATED HIGH CARBON STEEL; 26" LONG; 1 1/8" END PINS; 3/4" HITCH PIN HOLES. PAINTED BLUE WEIGHT:27 LBS

#### HEAT TREATED, 13 HOLE DRAWBAR-CATEGORY 2

FITS ALL TRACTORS WITH 32" LIFT ARM SPACING AND 1 1/8" BALL SOCKETS. MADE OF 1 1/4" X 3" HEAT TREATED HIGH CARBON STEEL; 32" LONG; 1 1/8" END PINS; 3/4" HITCH PIN HOLES. PAINTED GREEN WEIGHT: 33 LBS.

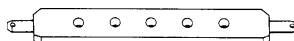

**DB431**

**PART NO.**

159-431

### CATEGORY 3

#### HEAT TREATED, 5 HOLE DRAWBAR-CATEGORY 3

FITS JOHN DEERE 5020, 8020; INTERNATIONAL 1206; MINN-MOLINE G1000; MASSEY 1130;A.C. D-21 WHEN EQUIPPED WITH CATEGORY 3 LIFT ARMS AND WHEN LIFT ARMS ARE ADJUSTED TO STANDARD 38" CATEGORY 3 SPACING. ALSO FITS ALL OTHER STANDARD CATEGORY 3 TRACTORS SO EQUIPPED. MADE OF 1 3/4" X 3 1/2" HEAT TREATED HIGH CARBON STEEL; 38" LONG; 1 7/16" END PINS; 1 1/4" HITCH PIN HOLES. PAINTED YELLOW WEIGHT:65 LBS.





# QUALITY & MODERN:

## OUR PERSONAL COMMITMENT

Providing Customer Satisfaction,  
Competitive Prices, Quality Products  
And Service You Can Rely Upon Since 1963.

Modern Ag Parts - Beaumont, Texas - Order Toll-Free 1-888-404-8908 - Fax Toll-Free 1-888-404-8910

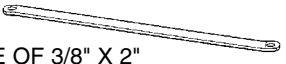
## STABILIZER ARMS

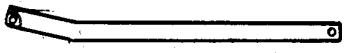
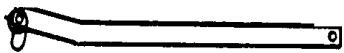
<b>RED</b>	<b>PART NO.</b> 159-621	<b>UNIVERSAL STABILIZER ARM-RIGHT OR LEFT</b> FITS 159-611 KIT. MADE OF 3/8" X 2" HEAT TREATED HIGH CARBON STEEL; 7/8" PIN HOLES ON 31-9/16" CENTERS. PAINTED RED OR BLUE		<b>SA-621</b> WEIGHT:6 LBS.
<b>BLUE</b>	<b>PART NO.</b> 159-623			
	<b>PART NO.</b> 159-622	<b>STABILIZER ARM-RIGHT OR LEFT</b> MADE OF 3/8" X 2" HEAT TREATED HIGH CARBON STEEL; 7/8" PIN HOLES ON 33-1/8" CENTERS. PAINTED RED		<b>SA-622</b> WEIGHT:7 LBS.
	<b>PART NO.</b> 159-626	<b>STABILIZER ARM-RIGHT OR LEFT</b> FITS MASSEY FERGUSON 65 WITH SHORT LIFT ARMS. MADE OF 3/8" X 2" HEAT TREATED HIGH CARBON STEEL; 7/8" PIN HOLES ON 30"CENTERS. PAINTED RED		<b>SA-626</b> WEIGHT:7 LBS.
	<b>PART NO.</b> 159-627	<b>STABILIZER ARM-RIGHT OR LEFT</b> FITS MASSEY-FERGUSON 65, 165, 175, & 180 STANDARD CLEARANCE. MADE OF 3/8" X 2"HEAT TREATED HIGH CARBON STEEL; 7/8" PIN HOLES ON 34" CENTERS. PAINTED RED		<b>SA-627</b> WEIGHT:7 1/2 LBS.
	<b>PART NO.</b> 159-6251	<b>STABILIZER ARM-LEFT HAND</b> FITS FORD 2000, 3000 MADE OF 3/8" X 2" HEAT TREATED HIGH CARBON STEEL 7/8" PIN HOLES ON 31-5/8" CENTERS. PAINTED RED		<b>SA-6251</b> WEIGHT:6 LBS
	<b>PART NO.</b> 159-6252	<b>STABILIZER ARM-RIGHT HAND</b> FITS FORD 2000, 3000 MADE OF 3/8" X 2"HEAT TREATED HIGH CARBON STEEL 7/8" PIN HOLES ON 31-5/8" CENTERS. PAINTED RED		<b>SA-6252</b> WEIGHT:6 LBS.

### CATEGORY 1 HEAVY DUTY ADJUSTABLE (RH OR LH)

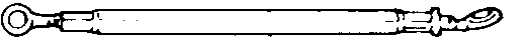
<b>PART NO.</b> 159-628	ONE PIECE FORGED ENDS-NO WELDS TO BREAK ADJUST FROM 27-1/2" TO 35" 7/8" PIN HOLES, 7/8" THREADS	
----------------------------	---	--

## STABILIZER KITS

<b>RED</b>	<b>PART NO.</b> 159-611		<b>SK-611</b>
<b>BLUE</b>	<b>PART NO.</b> 159-613	<b>STABILIZER KIT FOR CATEGORY 1 IMPLEMENTS WITH 7/8" DRAW PINS</b> REPLACES FERGUSON 677022. FITS FERGUSON ALL MODELS; FORD 9N , 2N , 8N , NAA, 600, 800; MASSEY FERGUSON 35 & 50. HAS HEAT TREATED 3/8" X 1-3/4" HIGH CARBON STEEL ARMS. CONTAINS; 2-159-621 ARMS, 2-159-631 BRACKETS, 2-150-6 PINS, 2-154-1533 LYNCH PINS. PAINTED RED	<b>WEIGHT: 18 LBS.</b>

## STABILIZER BRACKETS

<b>UNIVERSAL STABILIZER BRACKET-RIGHT OR LEFT</b> FITS 159-611 & 159-612 FERGUSON & FORD STABILIZER KITS. ACCOMMODATES P781 STABILIZER STUB PIN. PAINTED RED OR BLUE.		
<b>RED</b>	<b>PART NO.</b> 159-631	<b>BLUE</b>
	<b>PART NO.</b> 159-632	<b>SB-631</b>

**3 PT. & TRACTOR ACCESSORIES**

Stabilizer Straps

Compact Tractor Stabilizer Assemblies & Links

Modern Ag Parts - Beaumont, Texas - Order Toll-Free 1-888-404-8908 - Fax Toll-Free 1-888-404-8910

# STABILIZER STRAPS

**PART NO.** 159-511 **UPPER STAY STRAP, REPLACES: FORD-9N5374B & MF-181985M1.** **DS-511**  
 FITS FERGUSON, ALL MODELS; FORD 2N, 9N, 8N, NAA, 600, 700, 800, 900; OLIVER 550 AND  
 ALL OLIVER 3-POINT CONVERSION; MASSEY FERGUSON 35 & 50. MADE OF 1/4" X  
 1-1/2" HEAT TREATED HIGH CARBON STEEL. PAINTED RED. WEIGHT: 2 1/2 LBS.

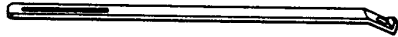

**PART NO.** 159-512 **LOWER STAY STRAP, REPLACES: FORD-9N5375B & MF-181986M1.** **DS-512**  
 FITS FERGUSON ALL MODELS; FORD 2N, 9N, 8N, NAA, 600, 700, 800, 900; OLIVER 550  
 AND ALL OLIVER 3-POINT CONVERSION; MASSEY FERGUSON 35 & 50. MADE OF 1/4" X  
 1-1/2" HEAT TREATED HIGH CARBON STEEL. PAINTED RED. WEIGHT: 2 LBS.

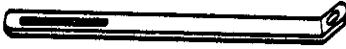

## COMPACT TRACTOR STABILIZER ASSEMBLIES & LINKS

FOR MOST COMPACT TRACTORS 15 HP TO 40 HP

### CHECK CHAIN STABILIZER ASSEMBLY ROUND

**PART NO.** 159-350 **Total Closed Length-13"**

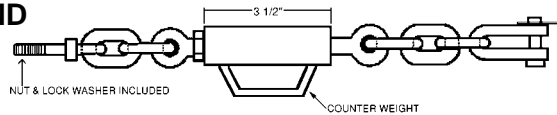

### CHECK CHAIN STABILIZER ASSEMBLY SQUARE

**PART NO.** 159-425 **Total Closed Length-24"**

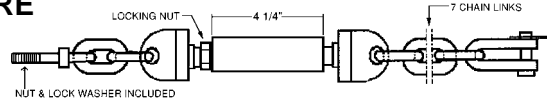

### CHECK CHAIN STABILIZER ASSEMBLY

**PART NO.** 159-630

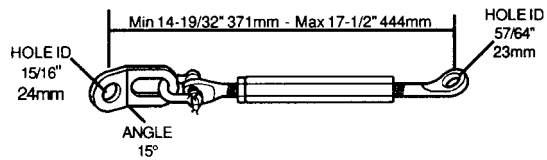

### CHECK CHAIN CLEVIS EYE BOLT

**PART NO.** 159-1645

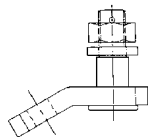

### ADJUSTABLE SIDE LINK - CAT 0

**PART NO.** 159-90  
7-1/2" Center Tube

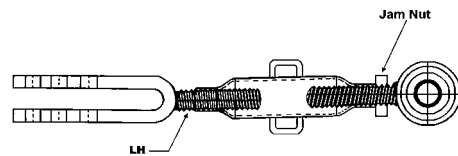

### ADJUSTABLE SIDE LINKS - CAT I

<b>PART NO.</b> 159-750 7-1/2" Center Tube	<b>PART NO.</b> 159-950 9-1/2" Center Tube	<b>PART NO.</b> 159-0115 11-1/2" Center Tube
--	--	--

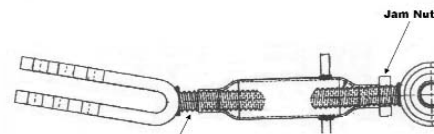

### L. H. SIDE LINKS - CAT I (Non-Adjustable)

**PART NO.** 159-1150

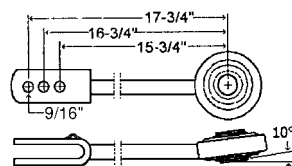

**PART NO.** 159-155

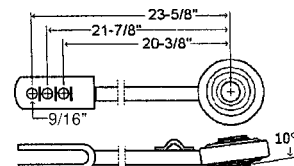

**PART NO.** 159-975

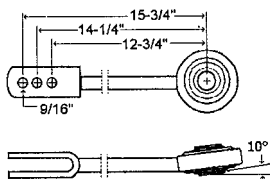

### ADJUSTABLE CLEVIS PIN For Side Links

**PART NO.** 650-604



Modern Ag Parts - Beaumont, Texas - Order Toll-Free 1-888-404-8908 - Fax Toll-Free 1-888-404-8910

## LIFT ARMS

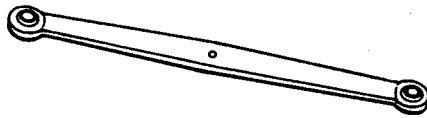

LA-335

PART NO.

159-331

### CATEGORY 1 RIGHT OR LEFT HAND LIFT ARM

FITS FERGUSON ALL MODELS; FORD 2N, 9N, 8N, NAA; MASSEY FERGUSON 35 & 50; OLIVER 550 AND ALL OLIVER 3-POINT CONVERSION; JOHN DEERE 1010. 1/2" X 2-1/2" ALLOY STEEL; 7/8" PIN HOLES ON BOTH ENDS; 31-3/4" BALL CENTERS; 34-1/4" OVERALL LENGTH. PAINTED RED.

WEIGHT: 11 LBS.

## LIFT ARMS FOR COMPACT TRACTORS

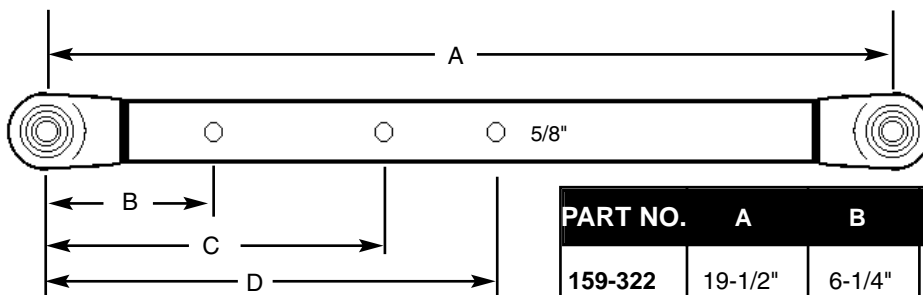

\*CATEGORY 1  
\*2-1/2" WIDE  
\*5/8" THICK

PART NO.	A	B	C	D
159-322	19-1/2"	6-1/4"	No Hole	No Hole
159-324	21-1/2"	7-1/4"	9-1/4"	No Hole
159-326	23-1/2"	8-1/2"	12"	13-3/4"
159-328	25-1/2"	8-1/2"	13"	14-3/4"
159-330	27-1/2"	6"	13"	16"
159-332	29-1/2"	6"	11-3/4"	15-1/2"

## LIFT ARM WELD ON ENDS

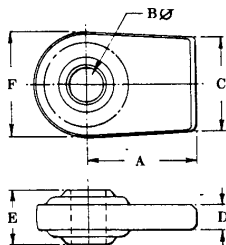

	PART NO.	A	B	C	D	E	F
CAT.1	159-1338	2-3/4	7/8	2-3/8	5/8	1-3/8	2-5/8
CAT.2	159-1342	3-1/8	1-1/8	2-3/4	3/4	1-3/4	3-1/8
CAT.3	159-1344	3-3/8	1-7/16	3	3/4	1-3/4	3-1/2
CAT.3 HD	159-1350	3-17/32	1-7/16	3-15/16	7/8	1-3/4	3-15/16

## LIFT ARM LEVELING ASSEMBLY

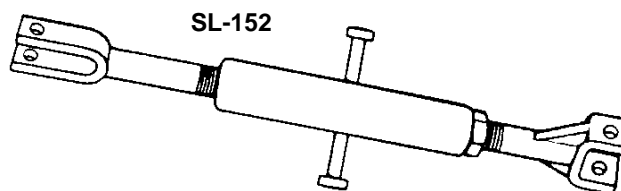

PART NO.  
159-152

### LIFT ARM LEVELING ASSEMBLY.

REPLACES; FORD NCA577A. PERMITS WIDE RANGE OF TILT  
 ADJUSTMENTS ON IMPLEMENTS. 7/8" NF THREADS; 19 1/4"  
 OVERALL CLOSED LENGTH. PAINTED RED 5/8" PIN HOLES WEIGHT: 8 LBS.

## CHECK CHAIN CLEVISES & EYE BOLT

### CHECK CHAIN CLEVIS

PART NO. 159-1642



USED TO FASTEN CHECK  
 CHAIN TO TRACTOR.

REPLACES:  
 FORD - APN582A  
 MASSEY FERGUSON - 180333M1

### CHECK CHAIN CLEVIS W/ CHAIN



PART NO. 159-1644

REPLACES: FORD - CBPN598A  
 MASSEY FERGUSON

### CHECK CHAIN CLEVIS EYE BOLT

PART NO. 159-1641



USED TO FASTEN CHECK CHAIN  
 TO LIFT ARMS. REPLACES  
 FORD - NCB660A.  
 ASSEMBLED WITH 9/16" NF NUT

# QUALITY & MODERN:

## OUR PERSONAL COMMITMENT

Providing Customer Satisfaction,  
 Competitive Prices, Quality Products  
 And Service You Can Rely Upon Since 1963.

Choose from the hundreds of items in this catalog or go on line at [www.modernusa.com](http://www.modernusa.com). Place your order from our huge warehouse facility, and our professional staff will process and shipped it to you the same day.

## Your Satisfaction is Guaranteed!

Modern Ag Parts - Beaumont, Texas - Order Toll-Free 1-888-404-8908 - Fax Toll-Free 1-888-404-8910

## SWINGING DRAWBAR KITS

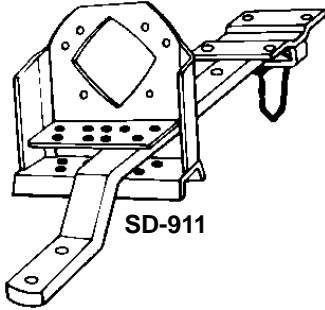

### SWINGING DRAWBAR KITS

FITS FORD 8N, 2N, 9N, NAA, 630, 631, 640, 641, 650, 651, 660, 661; FERGUSON T020, T030; MASSEY FERGUSON 35 & 50. KIT CONTAINS:  
1-159-921 DRAWBAR, 1-159-931 HINGE CLEVIS,  
1-159-932 DRAWBAR HANGER.  
PAINTED RED OR BLUE.  
WEIGHT 33 LBS.

**RED**

**PART NO.**

159-911

**BLUE**

**PART NO.**

159-912

## SWINGING DRAWBAR PARTS

SD-921

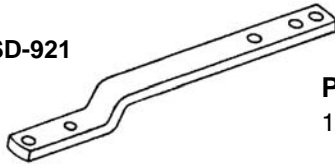

**PART NO.**

159-921

### SWINGING DRAWBAR

FITS ALL TRACTOR MODELS LISTED UNDER 159-911.  
MADE OF 1" X 2" HEAT TREATED HIGH CARBON STEEL,  
30" OVERALL LENGTH. PAINTED RED  
WEIGHT 15 LBS.  
FORD CONN805F



SD-931

**PART NO.**

159-931

### SWINGING DRAWBAR CLEVIS ASSEMBLY

FITS ALL TRACTOR MODELS LISTED UNDER 159-911.  
COMPLETE WITH DICHROMATE PLATED PINS.  
PAINTED RED  
WEIGHT 7 LBS.  
FORD NCA803B

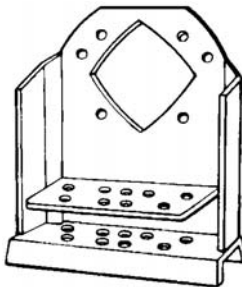

SD-932

**PART NO.**

159-932

### DRAWBAR HANGER

FITS ALL TRACTOR MODELS LISTED UNDER 159-911.  
USED WITH 159-921 DRAWBAR.  
ALL WELDED CONSTRUCTION. PAINTED RED.  
WEIGHT 11 LBS.  
FORD NCA809A

P-742

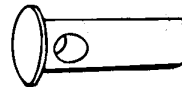

**PART NO.**

150-742

### SWINGING DRAWBAR CLEVIS PIN

FITS 159-911 & 159-931 ASSEMBLIES. 7/8"  
DIAMETER, COLD ROLLED STEEL, 3 1/2" OVERALL  
LENGTH.  
DICHROMATE PLATED.  
WEIGHT 1/2 LB.

**You can find all these items and more on our  
web site: [www.modernusa.com](http://www.modernusa.com)  
Make Modern Ag Parts Your #1 choice!**

Modern Ag Parts - Beaumont, Texas - Order Toll-Free 1-888-404-8908 - Fax Toll-Free 1-888-404-8910

## TOPLINK WELD ON BALL SOCKETS

### CATEGORY 0

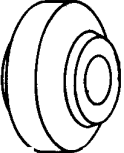
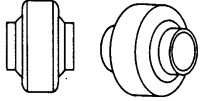
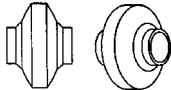
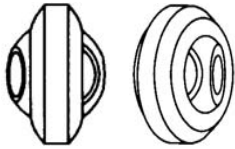
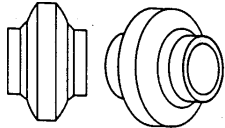
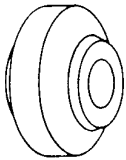
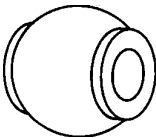
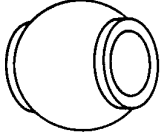
<b>PART NO.</b> 159-2226	<b>STANDARD DUTY CATEGORY 0 BALL SOCKET</b> FITS ALL CATEGORY 0 TOP LINKS AND LIFT ARMS, REQUIRING 2" O.D. SLEEVE; 3/4" SLEEVE WIDTH, 5/8" PIN HOLE, 1" THRU BORE. DICHROMATE PLATED (B2226)	 <b>B2226</b>
<b>CATEGORY 1</b>		
<b>PART NO.</b> 159-213	<b>STANDARD DUTY CATEGORY 1-1 7/8" O.D. SLEEVE</b> FITS ALL CATEGORY 1 TOP LINKS. 1-7/8" O.D.SLEEVE, 3/4" SLEEVE WIDTH, 3/4" PIN HOLE, 1-5/8" THRU BORE. NON PLATED.	 <b>B213</b>
<b>PART NO.</b> 159-212	<b>HEAVY DUTY CATEGORY 1-2 1/8" O.D. SLEEVE</b> FITS ALL CATEGORY 1 TOP LINKS. 2-1/8" O.D. SLEEVE, 7/8" SLEEVE WIDTH, 3/4" PIN HOLE, 1-5/8" THRU BORE. PLATED.	 <b>B212</b>
<b>CATEGORY 1 &amp; 2</b>		
<b>PART NO.</b> 159-236	<b>STANDARD DUTY CATEGORY 1 &amp; 2 SPEEDBALL</b> FITS ALL CATEGORY 1 OR 2 TOP LINKS. 2-3/8" O.D. SLEEVE, 7/8" SLEEVE WIDTH, 3/4" AND 1" PIN HOLES, 1-1/2" THRU 3/4" BORE, 1-1/4" THRU 1" BORE. PLATED.	 <b>B236</b>
<b>CATEGORY 2</b>		
<b>PART NO.</b> 159-214	<b>STANDARD DUTY CATEGORY 2-2 3/8" O.D.SLEEVE</b> FITS ALL CATEGORY 2 TOP LINKS. 2-3/8" O.D. SLEEVE WIDTH, 1" PIN HOLE, 1-3/4" THRU BORE. PLATED.	 <b>B214</b>
<b>CATEGORY 3</b>		
<b>PART NO.</b> 159-2229	<b>HEAVY DUTY CATEGORY 3</b> FITS ALL CATEGORY 3 TOP LINKS 3 1/8" O.D. SLEEVE; 1-1/4" SLEEVE WIDTH; 1-1/4" PIN HOLE; 1-3/4" THRU BORE. NON PLATED	 <b>B2229</b>
<b>SPECIAL TOP LINK BALLS</b>		
<b>PART NO.</b> 159-241	<b>JOHN DEERE &amp; OLIVER TOP LINK IMPLEMENT BALL</b> <b>CATEGORY 1</b> REPLACES: JOHN DEERE F2680; OLIVER 105968A DESCRIPTION: 3/4" PIN HOLE, 1-3/4" THRU BORE, 2" DIAMETER DICHROMATE PLATED	 <b>B241</b> <b>3054</b>
<b>PART NO.</b> 159-242	<b>JOHN DEERE &amp; OLIVER TOP LINK IMPLEMENT BALL</b> <b>CATEGORY 2</b> REPLACES; JOHN DEERE F2681; OLIVER 104585A DESCRIPTION: 1" PIN HOLE, 1-3/4" THRU BORE, 2" DIAMETER DICHROMATE PLATED	 <b>B242</b> <b>3055</b>

Modern Ag Parts - Beaumont, Texas - Order Toll-Free 1-888-404-8908 - Fax Toll-Free 1-888-404-8910

## LIFT ARM WELD ON BALL SOCKETS

### CATEGORY 1

**PART NO. STANDARD DUTY CATEGORY 1-FOR TRACTORS 30 H.P. OR LESS, 2 3/8" O.D.**

159-221 **SLEEVE**

FITS ALL CATEGORY 1 LIFT ARMS. 2 3/8" O.D. SLEEVE, 7/8" SLEEVE WIDTH,  
7/8" PIN HOLE, 1 3/8" THRU BORE.  
NON PLATED

WEIGHT 90LBS./C

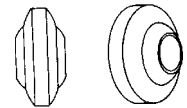

**B221**

### CATEGORY 1 & 2

**PART NO. HEAVY DUTY CAT.1 & 2 SPEEBALL-FOR TRACTORS OF 50 H.P. OR LESS**

159-232 FITS ALL CATEGORY 1 OR 2 LIFT ARMS. 2 3/4" O.D. SLEEVE, 1 3/16" SLEEVE WIDTH,  
7/8" & 1 1/8" PIN HOLES, 1 3/4" THRU BORE.  
PLATED

WEIGHT 150 LBS./C

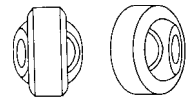

**B232**

**PART NO. EXTRA HEAVY CAT.1 & 2 SPEEBALL-FOR TRACTORS OF 50 H.P. OR MORE**

159-234 FITS ALL CATEGORY 1 OR 2 LIFT ARMS. 3 1/8" O.D. SLEEVE, 1 3/8" SLEEVE WIDTH,  
AND 7/8" & 1 1/8" PIN HOLES, 1 3/4" THRU BORE.  
PLATED

WEIGHT 205 LBS./C

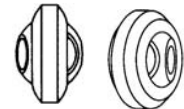

**B234**

### CATEGORY 2

**PART NO. STANDARD DUTY CATEGORY 2- FOR TRACTORS 30 H.P. OR LESS, 2 3/8" O.D.**

159-222 **SLEEVE**

FITS ALL CATEGORY 2 LIFT ARMS, 2 3/8" O.D. SLEEVE, 7/8" SLEEVE WIDTH,  
1 1/8" PIN HOLE, 1 5/16" THRU BORE.  
NON PLATED

WEIGHT 75 LBS./C

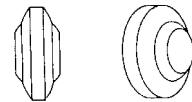

**B222**

**PART NO. EXTRA HEAVY DUTY CATEGORY 2-3 1/8" O.D. SLEEVE**

159-2216 FITS ALL CATEGORY 2 LIFT ARMS. 3 1/8" O.D.SLEEVE, 1 3/8" SLEEVE WIDTH,  
1 1/8" PIN HOLE, 1 3/4" THRU BORE.  
PLATED

WEIGHT 200 LBS./C

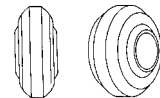

**B2216**

**PART NO. EXTRA HEAVY DUTY CATEGORY 2-2 3/4" O.D. SLEEVE**

159-2217 FITS ALL CATEGORY 2 LIFT ARMS. 2 3/4" O.D. SLEEVE, 1 1/4" SLEEVE WIDTH,  
1" PIN HOLE, 1 3/4" THRU BORE  
PLATED

WEIGHT 200 LBS./C

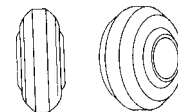

**B2220**

### CATEGORY 3

**PART NO. HEAVY DUTY CATEGORY 3-3 1/2 " O.D. SLEEVE**

159-2231 FITS ALL CATEGORY 3 LIFT ARMS. 3 1/2" O.D. SLEEVE, 1 3/8" SLEEVE WIDTH,  
1 7/16" PIN HOLE, 1 3/4" THRU BORE.  
NON PLATED

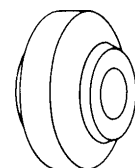

WEIGHT 200 LBS./C



**B2231**

Modern Ag Parts - Beaumont, Texas - Order Toll-Free 1-888-404-8908 - Fax Toll-Free 1-888-404-8910

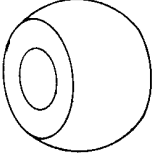
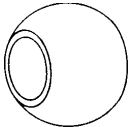
## SPECIAL LIFT ARM BALL SOCKETS

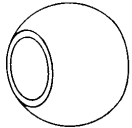
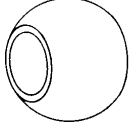
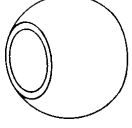
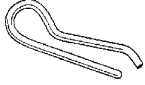
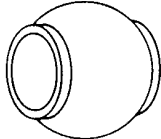
<b>PART NO.</b> 159-243	<b>FORD LIFT ARM REPLACEMENT BALL-CATEGORY 1</b> FITS FORD 3000, 4000, & 5000. HAS 7/8" PIN HOLE, 1 3/8" THRU BORE, 2 1/4" DIAMETER. DICHROMATE PLATED FORD DDN 995233		<b>56</b> <b>B243</b>
<b>PART NO.</b> 159-244	<b>FORD LIFT ARM REPLACEMENT BALL-CATEGORY 2</b> FITS FORD 3000, 4000, & 5000. HAS 1 1/8" PIN HOLE, 1 3/4" THRU BORE, 2 1/4" DIAMETER. DICHROMATE PLATED FORD C5NN557A		<b>57</b> <b>B244</b>
<b>PART NO.</b> 159-245	<b>RETAINER SPRING FOR 159-244.</b>		
<b>PART NO.</b> 159-247	<b>FORD LIFT ARM REPLACEMENT BALL-CATEGORY 2 (NARROW)</b> REPLACES: FORD C5NN557B. FITS 3000, 4000, & 5000. HAS 1 1/8" PIN HOLE, 1 3/8" THRU BORE, 2 1/4" DIAMETER		<b>3057</b> <b>B247</b>
<b>PART NO.</b> 159-249	<b>MASSEY FERGUSON LIFT ARM REPLACEMENT BALL-CATEGORY 1</b> REPLACES: MF - 886428M1. FITS MF35, MF240, MF250; IND 20D & 20E. HAS 7/8" PIN HOLE.		WEIGHT 101 LBS./C
<b>PART NO.</b> 159-250	<b>MASSEY FERGUSON LIFT ARM REPLACEMENT BALL-CATEGORY 2</b> REPLACES: MF - 886429M1. FITS MF135 & MF282. HAS 1-1/8" PIN HOLE. WEIGHT 101 LBS./C		
<b>PART NO.</b> 154-300	<b>RETAINER CLIP FOR 159-249 &amp; 159-250.</b> REPLACES: MF - 1860936M1.		
<b>PART NO.</b> 159-246	<b>OLIVER LIFT ARM REPLACEMENT BALL-CATEGORY 2</b> REPLACES; OLIVER 104519A. FITS ALL MODELS WITH CLAW TYPE LIFT ARMS. HAS 1 1/8" PIN HOLE, 1 3/4 " THRU BORE, 2 " DIAMETER. DICHROMATE PLATED		WEIGHT 70 LBS./C  <b>3056</b> <b>B246</b>

Modern Ag Parts - Beaumont, Texas - Order Toll-Free 1-888-404-8908 - Fax Toll-Free 1-888-404-8910

## TOPLINK REDUCING BUSHING

ALL bushing ARE PLATED

	<b>PART NO.</b> 159-829	<b>CATEGORY 1 TO 0</b> 5/8" I.D. X 3/4" O.D. X 1-5/8" OVERALL LENGTH	<b>INTERCHANGE NO.</b> B829
---	----------------------------	---	--------------------------------

	<b>PART NO.</b> 159-831	<b>CATEGORY 2 TO 1</b> 3/4" I.D. X 1" O.D. X 2" OVERALL LENGTH	B831
---	----------------------------	---	------

	<b>PART NO.</b> 159-833	<b>CATEGORY 3 TO 2</b> 1" I.D. X 1-1/4" O.D. X 2" OVERALL LENGTH	B833
---	----------------------------	---	------

## LIFT ARM REDUCING BUSHING

	<b>PART NO.</b> 159-828	<b>CATEGORY 1 TO 0</b> 5/8" I.D. X 7/8" O.D. X 1-3/8" OVERALL LENGTH	B828
---	----------------------------	---	------

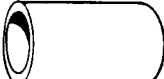
	<b>PART NO.</b> 159-821	<b>CATEGORY 2 TO 1</b> 7/8" I.D. X 1-1/8" O.D. X 1-3/4" OVERALL LENGTH	B821
---	----------------------------	---	------

	<b>PART NO.</b> 159-832	<b>CATEGORY 3 TO 2</b> 1-1/8" I.D. X 1-7/16" X 1-3/4" OVERALL LENGTH	B832
---	----------------------------	---	------



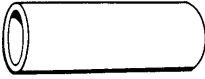



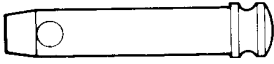

	<b>PART NO.</b> 159-2164	<b>CATEGORY 3 TO 2 LONG</b> 1-1/8" I.D. X 1-7/16" O.D. X 2-3/4" OVERALL LENGTH	2164 B8319
---	-----------------------------	---	---------------

	<b>PART NO.</b> 159-824	<b>CATEGORY 3 TO 2 EXTRA LONG</b> 1-1/8" I.D. X 1-7/16" O.D. X 3-1/4" OVERALL LENGTH	2166 B8320
---	----------------------------	---	---------------

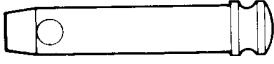
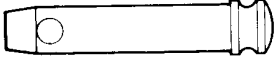

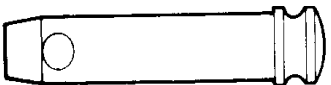
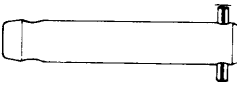
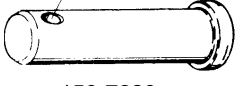

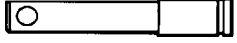

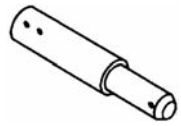





	<b>PART NO.</b> 159-95900	<b>CATEGORY 3 TO 2 EXTRA LONG</b> 1-1/8" I.D. X 1-7/16" O.D. X 4-1/4" OVERALL LENGTH	
---	------------------------------	---	--

	<b>PART NO.</b> 159-1846	<b>CATEGORY 3 TO 2 WITH HOLE</b> 1-1/8" I.D. X 1-7/16" O.D. X 2-1/2" OVERALL LENGTH	3010 B8312
---	-----------------------------	--	---------------

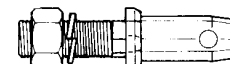
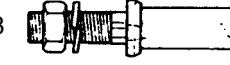
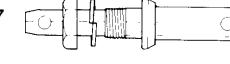
Modern Ag Parts - Beaumont, Texas - Order Toll-Free 1-888-404-8908 - Fax Toll-Free 1-888-404-8910

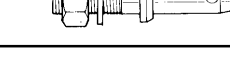
<b>TOPLINK PINS</b>				
<b>CATEGORY 0</b>				
<b>PART NO.</b> 150-776		5/8" DIA. X 2-3/4" USABLE REPLACES: CASE / IH - B500183	<b>INTERCHANGE NO.</b> P776	
<b>CATEGORY 1</b>				
<b>PART NO.</b> 150-4		3/4" DIA. X 2-3/4" USABLE REPLACES: FORD - 957E560, MF - 19546M1, CASE / IH - B500184	946 P771	
<b>PART NO.</b> 150-12		3/4" DIA. X 3-7/8" USABLE REPLACES: MF - 195589MI, AC - 339942, CASE / IH - B500185	1002 P772	
<b>PART NO.</b> 150-1464		3/4" DIA. X 4-3/4" USABLE REPLACES: FORD - E381T9, CASE / IH - B500186	1464 P7715	
<b>CATEGORY 2</b>				
<b>PART NO.</b> 150-1674		1" DIA. X 4 9/16" USABLE REPLACES: FORD - C5NN486A	185-8730 P774	
<b>PART NO.</b> 150-1892		1" DIA. X 5-3/8" USABLE REPLACES: FORD - E2016F9, AC - 345552	1892 P7720	
<b>CATEGORY 3</b>				
<b>PART NO.</b> 150-7711		1-1/4" DIA. X 4 -11/16" USABLE REPLACES: MF - 3670731X1, IH - 392211TI, CASE - A76285, AC240251, CASE / IH - B500189	P7711	
<b>HEAVY DUTY DRAW PINS</b>				
	<b>PART NO.</b>	<b>TYPE</b>	<b>DESCRIPTION</b>	<b>INTERCHANGE NO.</b>
	150-3032	CAT. 2	1-1/8" DIA. X 4-3/4" USABLE	3032
	150-3132	CAT. 2	1-1/8" DIA. X 7-1/2" USABLE	3132
	<b>PART NO.</b>	<b>TYPE</b>	<b>DESCRIPTION</b>	<b>INTERCHANGE NO.</b>
	150-7230	CAT. 2	1-1/8" DIA. X 9" USEABLE	7239
	150-7230	CAT. 3	1-7/16" DIA. X 4-1/2" USABLE	P7230
	150-7231	CAT. 3	1-7/16" DIA. X 6-1/2" USABLE	P7231
<b>INTERNATIONAL TOPLINK PINS</b>				
	<b>PART NO.</b>	<b>TYPE</b>	<b>DESCRIPTION</b>	
	150-110	CAT. 2	1" X 4" (1-5/16" SHOULDER); REPLACES: 528084R1, 3074756R1, B500182	
	150-111	CAT.1	3/4" X 3" (1-3/4" SHOULDER); REPLACES: 528081R1, B500181	
<b>JOHN DEERE BALL SOCKET PIN</b>				
<b>PART NO.</b> 150-1010		CAT. 2	1" X 3-3/4" REPLACES F268-3R-81302 (FOR USE WITH 159-242 BALL SOCKETS)	
<b>LIFT PIN FOR PLANTER</b>				
<b>PART NO.</b> 110-1171	MAXI-MERGE LIFT PIN CAT II-III 7000-7100 REPLACES OEM# A17383			

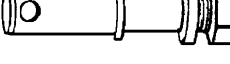
Modern Ag Parts - Beaumont, Texas - Order Toll-Free 1-888-404-8908 - Fax Toll-Free 1-888-404-8910

<b>IMPLEMENT PINS</b>						
PART NO.		PIN DIA.	THREAD DIA.	USABLE LENGTH	OVERALL LENGTH	INTERCHANGE NO.
150-7220		<b>CATEGORY 0 ADJUSTABLE</b>				
		5/8"	5/8"	1-5/16"	3-7/8"	P7220
		REPLACES CASE / IH: B500195				
150-5		<b>CATEGORY 1 ADJUSTABLE</b>				
		7/8"	7/8"	1-5/8"	5-5/16"	P722
		REPLACES CASE / IH: B500196				
150-10		<b>CATEGORY 1 FORGED</b>				
		7/8"	7/8"	1-3/4"	5 1/2"	P728
		REPLACES CASE / IH: B500197				
150-1341		<b>CATEGORY 1 LONG ADJUSTABLE</b>				
		7/8"	7/8"	2-1/4"	6-1/4"	3000
		REPLACES CASE / IH: B500198				
150-1677		<b>CATEGORY 1 FORGED LONG</b>				
		7/8"	7/8"	2-1/4"	6-1/2"	P7245
		REPLACES CASE / IH: B500199				
150-724		<b>CATEGORY 1 TO 2 ADJUSTABLE</b>				
		1-1/8"	7/8"	1-3/4"	5-3/16"	P724 1132A
150-7		<b>CATEGORY 1 TO 2 FORGED</b>				
		1-1/8"	7/8"	1-3/4"	5-1/4"	P7240 1432A
150-1678		<b>CATEGORY 1 TO 2 FORGED LONG</b>				
		1-1/8"	7/8"	2-1/4"	6-5/16"	P7246
150-1887		<b>CATEGORY 1 &amp; 2 FORGED</b>				
		7/8" & 1-1/8" 1"		1-3/4"	7-1/2"	P7249
150-721		<b>CATEGORY 2 ADJUSTABLE</b>				
		1-1/8"	1-1/8"	1-3/4"	6-1/4"	P721
150-720		<b>CATEGORY 2 FORGED</b>				
		1-1/8"	1-1/8"	1-3/4"	6-1/4"	P7212
150-730		<b>CATEGORY 2 TO 1 FORGED</b>				
		7/8"	1-1/8"	1-3/4"	5-3/4"	3022 3032A
150-7211		<b>CATEGORY 2 TO 3 ADJUSTABLE</b>				
		1-7/16"	1-1/8"	2"	6-	P7211 1/2"
150-13		<b>REPLACES KUBOTA NO. 32240-37695</b>				
		3/4"	16MM-1.5	1-5/8"	4-5/16"	
150-11		<b>REPLACES KUBOTA NO. 67950-77420</b>				
		3/4"	12MM-1.25	1-11/16"	3-9/16"	

Modern Ag Parts - Beaumont, Texas - Order Toll-Free 1-888-404-8908 - Fax Toll-Free 1-888-404-8910

## STABILIZER PINS

PIN DIA.	THREAD DIA.	USABLE LENGTH	OVERALL LENGTH	INTERCHANGE NO.
----------	-------------	---------------	----------------	-----------------

PART NO. 150-6		FOR STD. STABILIZER ARMS FORD 230044, MF181777M1				
		7/8"	5/8"	3/8"	2-5/8"	P781
						1006
				3169		

PART NO. 150-163		FOR FORGED STABILIZER ARMS				
		7/8"	5/8"	1/2"	2-3/4"	168
						1006-3

PART NO. 150-14		MOWER ANCHOR PIN FORD 141185, MF668154M1				
		7/8"	5/8"	1 1/4"	3-1/8"	107
						P785
				3125		

PART NO. 150-165		STABILIZER BRACKET PIN FOR FORD & MF			
		7/8"	7/8"	5/8"	3-1/8"

PART NO. 150-167		LINK STAY ANCHOR ASSEMBLY MF65			
		3/4"	7/8"	5/8"	3"

## PTO LOCK PINS

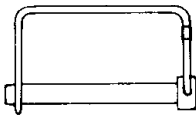

Square Handle

**PART NO.**  
156-516

5/16" DIA. PIN X 2-1/4" USABLE



Round Handle

PART NO.	PIN DIA.	USABLE
156-517	1/4"	2"
156-518	5/16"	2-1/4"
156-519	3/8"	3"

## ASSORTMENT / DISPLAY RACKS LESS PINS & HEADER

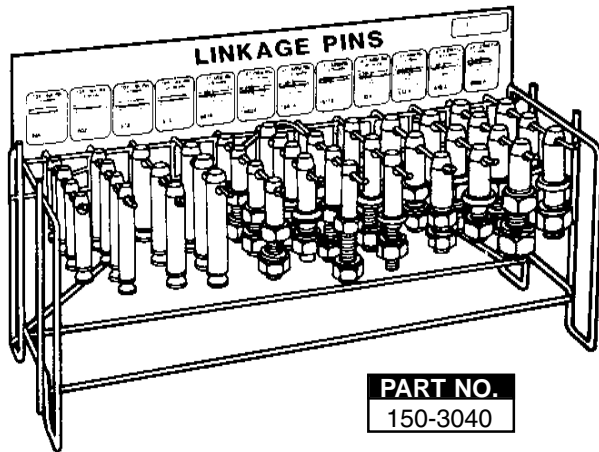

**PART NO.**  
150-3040

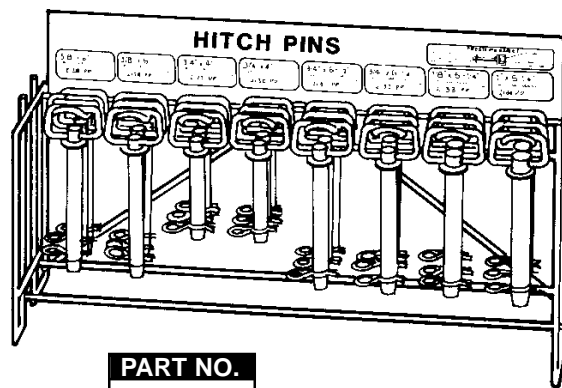

**PART NO.**  
156-3044

### HEADER SIGNS

For 150-3040 & 150-3044

### PART NO.

156-3050  
156-3051

### DESCRIPTION

Hitch Pin Header  
Linkage Pin Header

Modern Ag Parts - Beaumont, Texas - Order Toll-Free 1-888-404-8908 - Fax Toll-Free 1-888-404-8910

# HAIR / HITCH PIN CLIPS

( ACTUAL SIZE SHOWN )

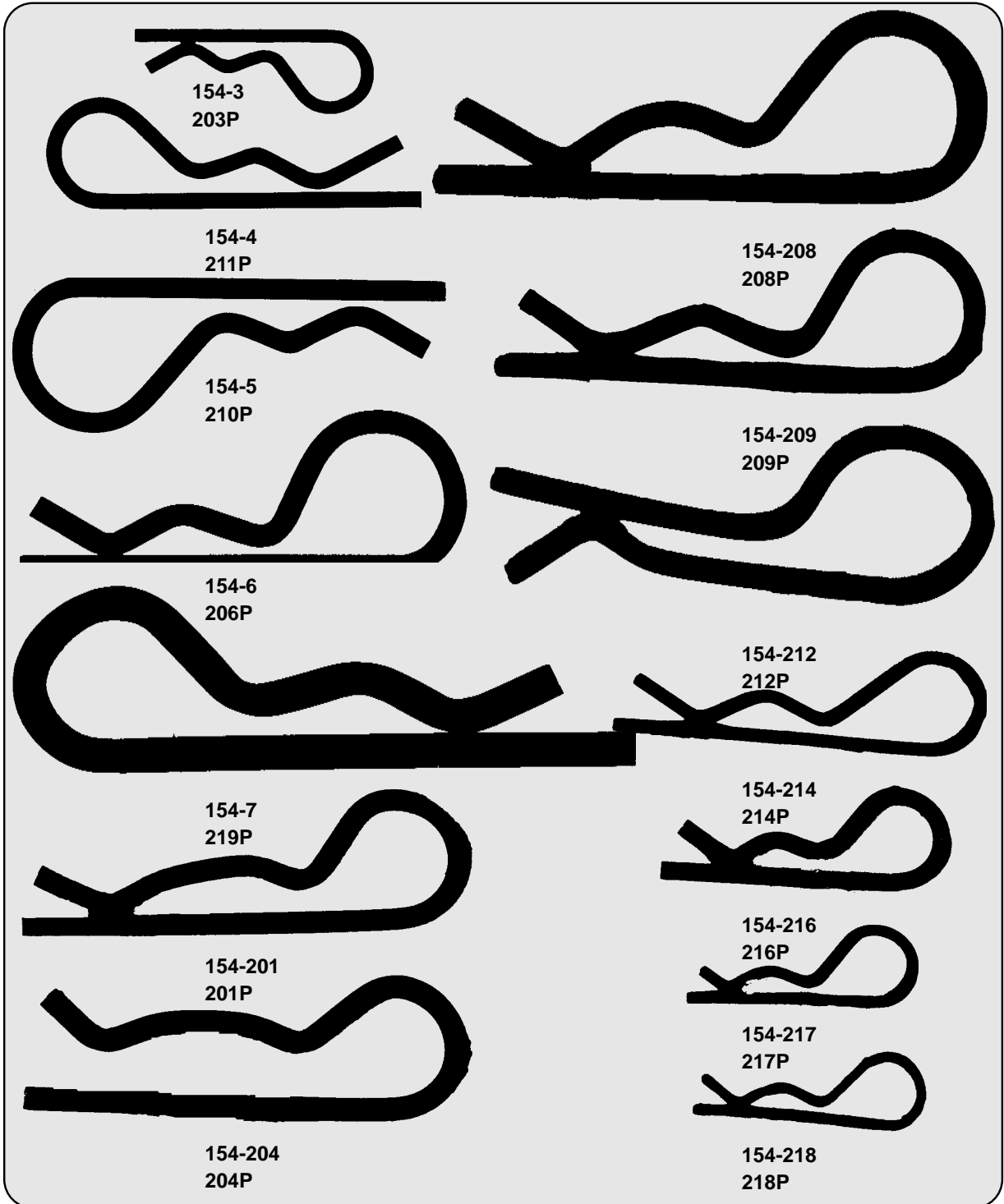

Modern Ag Parts - Beaumont, Texas - Order Toll-Free 1-888-404-8908 - Fax Toll-Free 1-888-404-8910

### FORGED LINCH PINS

**PLATED**

PART NO.		SIZE
154-1700	P7919	3/16" X 1-3/8"
154-1600	P794	1/4" X 1-3/4"
154-2709	P7915	5/16" X 1-3/4"
154-1533	P791	7/16" X 1-3/4"
154-1924 (HEAVY DUTY BLACK RING)	P7913	7/16" X 1-3/4"

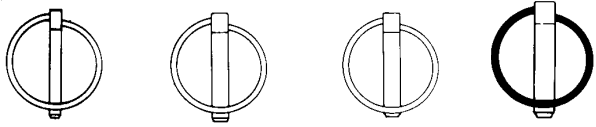

154-1600  
154-1700
154-2709
154-1533
154-1924

**100 PER BAG    PRICED EACH**

### CLIP PIN



COMPRESSION TYPE CLIP PIN  
FITS PINS WITH 5/16" HOLE. 5/16"  
DIAMETER: 3 1/2" LONG, ZINC PLATED

**PART NO.**  
150-793

### PRESTO PIN

**PLATED**

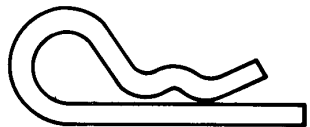

PART NO.	SIZE	FOR PIN DIA.
154-8	5/16" X 3-15/16"	3/4" - 1 1/4"

### HAIR / HITCH PIN CLIP ASSORTMENT

**PART NO.**  
154-15



### HPC-15

SET CONTAINS:

- 3 - 154-3
- 4 - 154-4
- 4 - 154-5
- 4 - 154-6

HANDIEST ASSORTMENT FOR THE IN-THE-FIELD BOX. THE RIGHT SIZE AND EXACT COUNT FOR REPLACEMENT PARTS.

### HAIR / HITCH PIN CLIPS

ACTUAL SIZE SHOWN ON PREVIOUS PAGE



**PLATED-PACKAGED 100 PER BOX**

PART NO.	MFG. NO.	HP NO.	WIRE DIA.	OVERALL LENGTH	FOR SHAFT DIA.
154-3	203P	HP6	3/32"	1-5/8"	1/4" - 1/2"
154-4	211P	HP5	1/8"	2-9/16"	7/16" - 3/4"
154-5	210P	HP4	5/32"	2-15/16"	5/8" - 1"
154-6	206P		11/64"	3-1/4"	5/8" - 1"
*154-7	219P	HP2	1/4"	4-3/8"	7/8" - 1-1/4"
**154-201	201P		9/64"	3"	5/8" X 1"
**154-204	204P		11/64"	3"	5/8" X 1"
154-208	208P	HP3	3/16"	3-3/4"	1 - 1/4"
154-209	209P		5/32"	3-5/16"	1 - 1/8"
**154-212	212P		11/64"	3-7/16"	7/8" X 1"
154-214	214P	HP8	3/32"	2-1/2"	3/4"
154-216	216P		1/8"	1-15/16"	3/4"
154-217	217P		5/64"	1-9/16"	1/2"
154-218	218P		1/16"	1-9/16"	1/2"

**\*PACKAGED 50 PER BOX\*\*FOR RECTANGULAR SHAFT**

Modern Ag Parts - Beaumont, Texas - Order Toll-Free 1-888-404-8908 - Fax Toll-Free 1-888-404-8910

# Modern Ag Parts

## REPLACEMENT PARTS FOR MODERN ROCK AUGERS

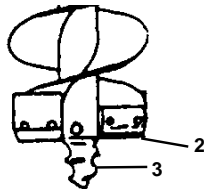

ITEM	PART NO.	DESCRIPTION
2	105-4321	Blade 6"
2	105-4314	Blade 9"
2	105-4318	Blade 12"
2	105-4312	Blade 15"
2	105-4311	Blade 18"
3	164-1401	Screw Point

SCREW POINT OR COMPLETE ROCK AUGER INTERCHANGEABLE WITH SOUTHEAST AND IMCO.

## COMPLETE REPLACEMENT HEAD AND ASSEMBLY FOR MODERN STANDARD AUGERS

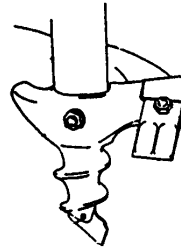

PART NO.	SIZE
507-6151A	FOR 6" AUGERS
507-6157A	FOR 9" AUGERS
507-6158A	FOR 12"-15"-18"-24"-28" AUGERS

## REPLACEMENT PARTS FOR MODERN STANDARD AUGERS

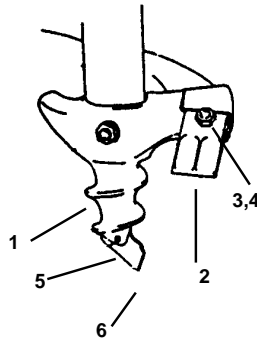

ITEM	PART NO.	DESCRIPTION
2-3-4	507-6112A	PHD Blade w/Hardware
5-6	507-6106A	PHD Tip and Roll pin

INTERCHANGEABLE WITH ALL 5-STAR AND SOUTHEAST AUGERS.

**Fast Shipping - Friendly Service**  
**New Products**  
**WE GUARANTEE YOUR SATISFACTION!**

Modern Ag Parts - Beaumont, Texas - Order Toll-Free 1-888-404-8908 - Fax Toll-Free 1-888-404-8910



WE'RE BREAKING NEW GROUND

**FARM AUGERS**

PART NO.	SIZE
507-3116P	6"
507-3119P	9"
507-3112P	12"

Has safety hub, 2 flute pilot bit, flying runs 2/3 up shaft.

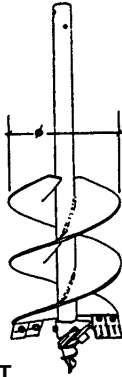

AUGERS FIT 2" OUTPUT SHAFT

**PTO AGGRESSOR AUGERS**

PART NO.	SIZE
507-3165P	9"
507-3168P	12"
507-3175P	15"
507-3176P	18"

Has safety hub, triple flute tri-flow pilot bit, flying runs all the way up the shaft, double flying runs up the first 1/3 of the shaft.

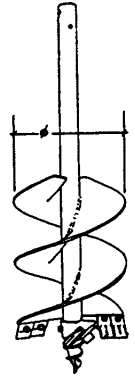

AUGERS FIT 2" OUTPUT SHAFT

**PTO AGGRESSOR ROCK AUGERS**

PART NO.	SIZE
507-3179P	9"
507-3180P	12"

Same as the PTO Aggressor but has a Carbide Tri-Flow Pilot Bit and Carbide Teeth



AUGERS FIT 2" OUTPUT SHAFT

**FARM & PTO AGGRESSOR 12" AUGER EXTENSION**

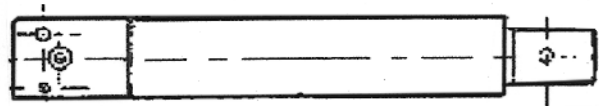

PART NO.	SIZE	DESCRIPTION
507-6164P	12"	ROUND EXTENSION HUB

**REPLACEMENT PARTS FOR PTO AGGRESSOR ROCK AUGERS**

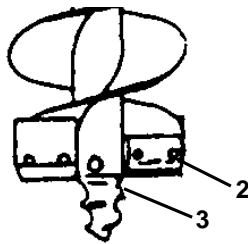

ITEM	PART NO.	DESCRIPTION
2	507-6120	9"& 12" TRI-FLOW PILOT BIT CARBIDE
3	507-6102	9"& 12" 40/50 TOOTH CARBIDE

SCREW POINT OR COMPLETE ROCK AUGER INTERCHANGEABLE WITH SOUTHEAST AND IMCO.

**REPLACEMENT PARTS FOR FARM & PTO AGGRESSOR AUGERS**

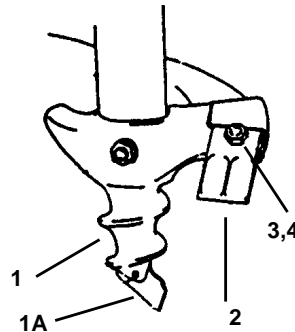

ITEM	PART NO.	DESCRIPTION
1	507-6115	FARM AUGER PILOT BIT
1A	507-6118	PTO AGGRESSOR TRI FLOW PILOT BIT
2	507-6100	40/50 AUGER TOOTH
3	412-6769	CARRIAGE BOLT
4	412-0062	LOCK NUT

Modern Ag Parts - Beaumont, Texas - Order Toll-Free 1-888-404-8908 - Fax Toll-Free 1-888-404-8910

## POST HOLE DIGGER CUTTING EDGES

### DANUSER

THESE POST HOLE DIGGER AUGER EDGES FEATURE SERRATED EDGES, AND ARE REPLACEMENTS FOR DANUSER POST HOLE DIGGERS. COMPLETE SET WITH BOLTS AND NUTS.



PART NO.	REPLACES DANUSER #	SIZE
164-1211	7785	9"
164-1213	7791	12"

## WORKSAVER

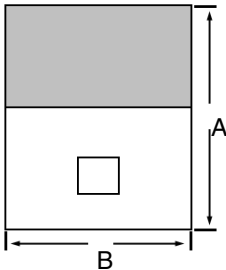

**REDCLAW**  
**PART NO.**  
164-1510

**SIZE**  
A = 3",  
B = 2",  
3/8" Thick

Uses 1/2" Carriage Bolt.

## HOWSE

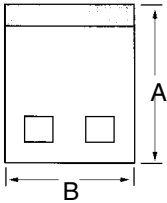



Uses 7/16" Carriage Bolt.

PART NO.	SIZE
164-1410	A = 2-1/2", B = 2-1/8", 1/4" Thick
164-1411	A = 2-1/2", B = 3", 1/4" Thick

## POST HOLE DIGGER POINTS

REPLACEMENTS FOR: DANUSER, FORD, WORKSAVER, SPEECO AND OTHER UNITS USING 1 1/4"-7 MALE THREADS.

PART NO.	REPLACES DANUSER #	TYPE
164-1201	831	SCREW
164-1202	899	FISH TAIL

## SPEECO

FOR SPEECO, MODEL #65 POST HOLE DIGGER W/ 9" AUGER.

PART NO.	PART NO.
164-1051 Outer Edge	164-1052 Inner Edge



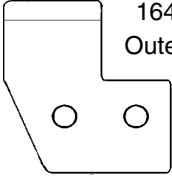
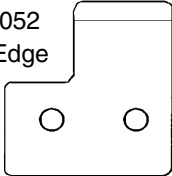

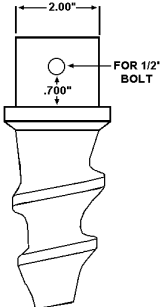
REPLACES: MODERN, HOWSE  
SHAVER & OTHER  
UNITS USING BOLT ON POINTS.

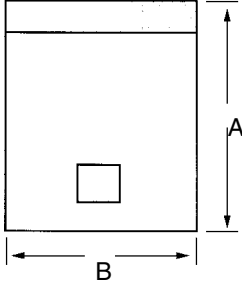

**PART NO.**  
164-1401

## VASSAR



Uses 7/16" Carriage Bolt.

PART NO.	SIZE
164-1310	A = 3", B = 1-7/8", 1/4" Thick

Modern Ag Parts - Beaumont, Texas - Order Toll-Free 1-888-404-8908 - Fax Toll-Free 1-888-404-8910

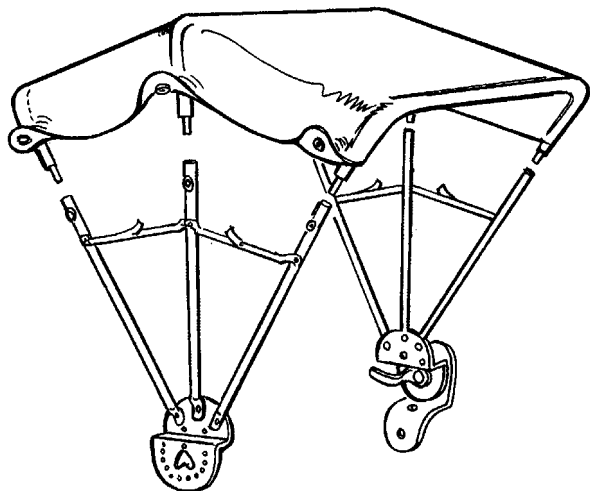

**NEW! HAMMERBLOW / SNOWCO  
BUGGY TOP TRACTOR CANOPIES**

*Please order frame, cover and bracket separately.*

**Features:**

- 180 backward or forward rotation for operator comfort
- Built to withstand hard field usage and strong winds
- Frame constructed of tubular steel
- Frames are compatible with McGregor brackets
- All metal parts, including frame and mounting brackets are zinc plated for rust resistance and lasting appearance
- Covers are available in colors to match most tractors
- Covers are made of heavy canvas anchored to the frame by front and rear hems and snap fasteners
- Covers are treated with water repellent material
- Two types of brackets cover inventory for most tractors- Bracket design allows Snowco sun shade to fit over most tractor rollover protection systems

**3-Bow Canopy Frames**

Frames are packaged in attractive display carton.

MAP No.	Width	Mfg. No.	McGregor No.
756-2001	40"	TBT-3	F-1
756-2003	48"	JBT-3	F-2

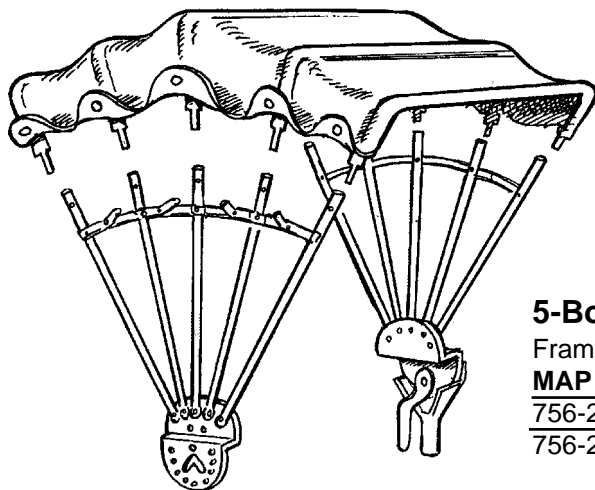

**5-Bow Canopy Frames**

Frames are packaged in attractive display carton.

MAP No.	Width	Mfg. No.	McGregor No.
756-2002	40"	TBT-5	P-9
756-2004	48"	JBT-5	F-59

**Canvas Covers for Hammerblow - Snowco Canopy Frames**

Covers are water resistant to provide long service life.

For Frame No.	Red Part No.	Yellow Part No.	Blue Part No.	White Part No.
756-2001(TBT-3)	756-2060	756-2061	756-2062	756-2063
756-2002(TBT-5)	756-2070	756-2071	756-2072	756-2073
756-2003(JBT-3)	756-2080	756-2081	756-2082	756-2083
756-2004(JBT-5)	756-2090	756-2091	756-2092	756-2093

Modern Ag Parts - Beaumont, Texas - Order Toll-Free 1-888-404-8908 - Fax Toll-Free 1-888-404-8910

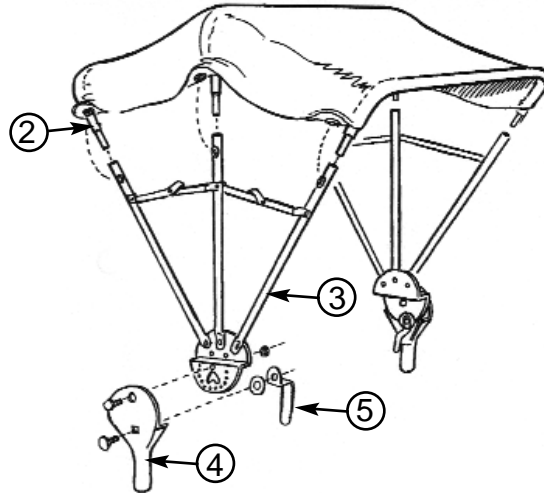

**Repair Parts List for Hammerblow - Snowco Canopy Frames**

Please call for price and availability on items not shown.

Item No.	MAP No.	Mfg. No.	Description	Qty. Needed
2	756-2052	405250	Bow for TBT-40 Frame	3 or 5
2	756-2053	405253	Bow for JBT-48 Frame	3 or 5
3	756-2054	405264	3-Bow Leg Assembly	2
3	756-2055	405266	5-Bow Leg Assembly	2
4	756-2056	405252	Mounting Paddle	2
5	756-2057	405201	Locking Handle	2

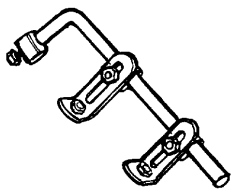

756-2050



756-2051

**Mounting Brackets for Hammerblow-Snowco Canopy Frames**

Axle bracket is easy fit to round, square or hex shape axles. Fender bracket allows for ROPS compatibility.

MAP No.	Mfg. No.	Description
756-2050	405-344	Fender Bracket
756-2051	405-241	Axle Bracket

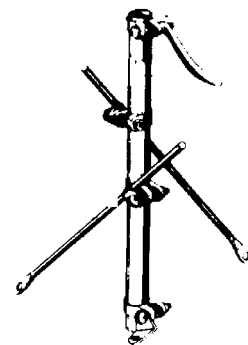

**Hammerblow - Snowco Universal Bracket for Umbrellas**

MAP No.	Model No.	Description
757-200	48	Universal Bracket for TU-50 & TU-56

Modern Ag Parts - Beaumont, Texas - Order Toll-Free 1-888-404-8908 - Fax Toll-Free 1-888-404-8910



**NEW! Hammerblow - Snowco Umbrellas for Agricultural, Construction, Lawn & Grounds Care**

Designed for wide adjustability and simple installation to fit most agricultural, construction, & lawn and grounds care equipment. They are built to withstand strong winds and feature easy installation and swivel operation.

- Preassembled components, designed for fast installation and removal
- Available in 41.5" for lawn grounds care applications and 54" for agricultural and construction applications
- Yellow dichromate zinc plated tubular steel provides a corrosion resistant, durable finish. No painted parts.
- Four oil-tempered steel bows form a rigid umbrella framework that withstands hard field use and strong winds
- Water resistant 10oz. Canvas duck covers are durable stitched and have corners that are reinforced with leather and heavy steel grommets
- Ball joint swivels to provide maximum adjustment for individual needs
- Easy removal from mounting bracket when overhead obstructions prevent use

**Hammerblow - Snowco Umbrellas for Agricultural & Construction Use - 54" Width**

Note that Umbrellas listed below do not have brackets.

*Please order brackets separate.*

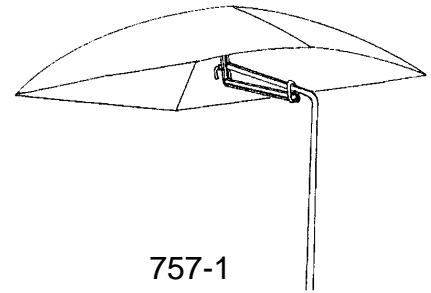

MAP No.	Model No.	Description
757-1	TU-50	Umbrella with Red & White Cover
757-2	TU-50	Umbrella with Yellow Cover
757-3	TU-50	Umbrella with Blue & White Cover
757-11	TU-56	Deluxe Umbrella with Red & White Cover
757-12	TU-56	Deluxe Umbrella with Yellow Cover
757-13	TU-56	Deluxe Umbrella with Blue & White Cover

**Hammerblow - Snowco Covers for Standard and Deluxe Umbrellas**

MAP No.	Model No.	Color
757-16	TU-50	Red & White
757-102	TU-50	Yellow
757-103	TU-50	Blue & White
757-116	TU-56	Red & White
757-112	TU-56	Yellow
757-113	TU-56	Blue & White

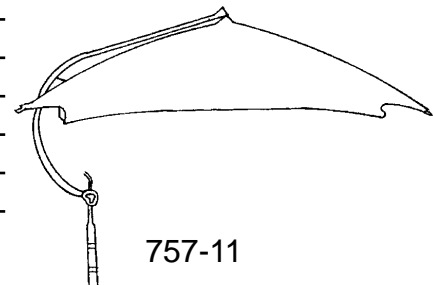

Modern Ag Parts - Beaumont, Texas - Order Toll-Free 1-888-404-8908 - Fax Toll-Free 1-888-404-8910

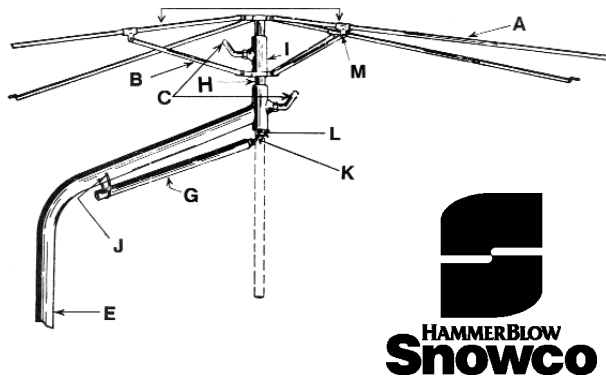

### Repair Parts List for Hammerblow - Snowco TU-50 Umbrellas

ILL.	MAP No.	Mfg.No	Description	Qty
A	757-301	405101	Bow	4
B	757-302	105102	Push Rods	4
C	757-430	405103	Lock Handle	2
E	757-304	405095	Offset Shaft	1
G	757-305	405354	Lower Section	1
J	757-308	405108	U Wire Clip	1
K	757-309	405109	Chain	1
L	757-312	491146	Roll Pin	1
N	757-313	405113	Frame Assembly	1

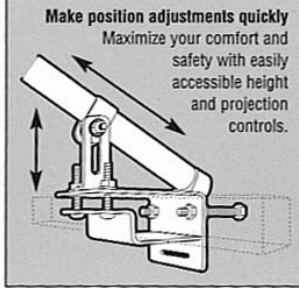

### NEW! Hammerblow - Snowco Rollover Mounted Tractor Umbrella

"Stay safe in the shade - mounts in a minute"

This umbrella mounts direct to the rollover bar without drilling, using four 3/8" bolts and a sturdy frame. Fits all ROPS bars from 2" X 2" to 3" X 3". Attaches easily - opens, closes and adjusts easily with one hand operation. 10 oz. canvas duck covers available in yellow or white.

#### Complete ROPS Units

MAP No.	Mfg.No	Description
757-500	405969	Umbrella, Bracket, & Yellow Cover
757-501	405968	Umbrella, Bracket, & White Cover

#### Covers only for ROPS Umbrella

MAP No.	Mfg.No	Description
757-502	405375	Yellow Cover Only
757-503	405374	White Cover Only

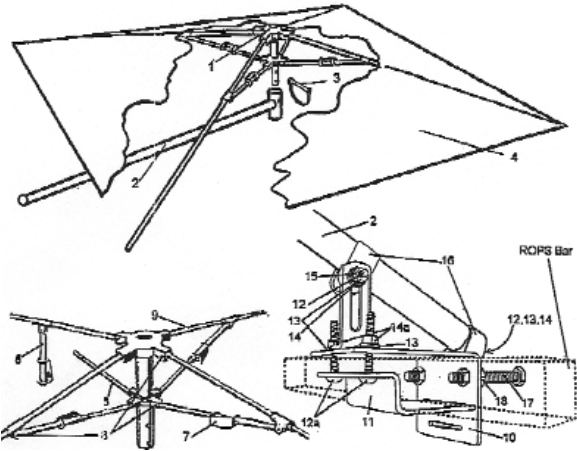

### Repair Parts List for Hammerblow - Snowco RU-50 ROPS Tractor Umbrellas

ILL.	MAP No.	Mfg.No	Description	Qty
1	757-520	405163	ROPS Frame	1
2	757-521	405165	ROPS Shaft w/Tee	1
3	757-522	405258	Rd.Lock Pin	1
5	757-434	405134	Push Rod Tube	4
6	757-436	405135	Push Rod	4
7	757-435	405140	Push Rod Clip	4
8	757-444	491175	Push Rod Rivet	12
9	757-433	405133	Bow with Clevis	4
10	757-524	454705	Top ROPS Bracket	1
11	757-525	450250	Bottom ROPS Bracket	1
12	757-526	490212	3/16 X 2-1/2 Carr Screw	4
13	757-527	491071	3/8" Lock Washer	4
14	757-528	491003	3/8" Nut	4
15	757-529	491061	3/8" Flat Washer	1
16	757-530	405204	Tube Clamp	2
17	757-531	490215	1/2" X 3-1/2 Bolt	2
18	757-532	490216	1/2" Nut	2

Modern Ag Parts - Beaumont, Texas - Order Toll-Free 1-888-404-8908 - Fax Toll-Free 1-888-404-8910

## Hammerblow - Snowco TU-46 Umbrella for Lawn & Garden Tractors -41.5" Width

The strongest-toughest Lawn and Garden Umbrella on the market. Note that Umbrella listed below does not have bracket or cover. Please order bracket & cover separate. Not all covers listed below are stock items. Please call for availability and price.



MAP No.	Mfg.No.	Description
757-1000	405385	Garden Umbrella
757-1001	405900	Universal Bracket for TU-46*
757-1002	405544	Cover, Green
757-1003	405545	Cover, Blue
757-1004	405546	Cover, Orange
757-1005	405547	Cover, Red
757-1006	405548	Cover, White
757-1007	405549	Cover, Yellow
757-1008	405550	Cover, Blue & White
757-1009	405551	Cover, Orange & White
757-1010	405552	Cover, Yellow & White
757-1011	405553	Cover, Red & Yellow
757-1012	405556	Cover, Green & White

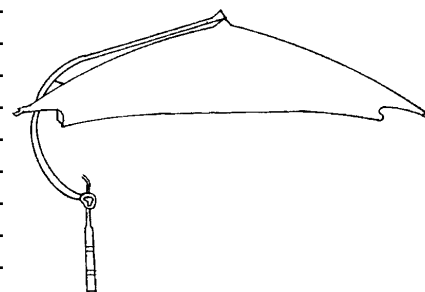

\*TU-46 bracket uses the hitch point of any lawn tractor for a rigid installation.

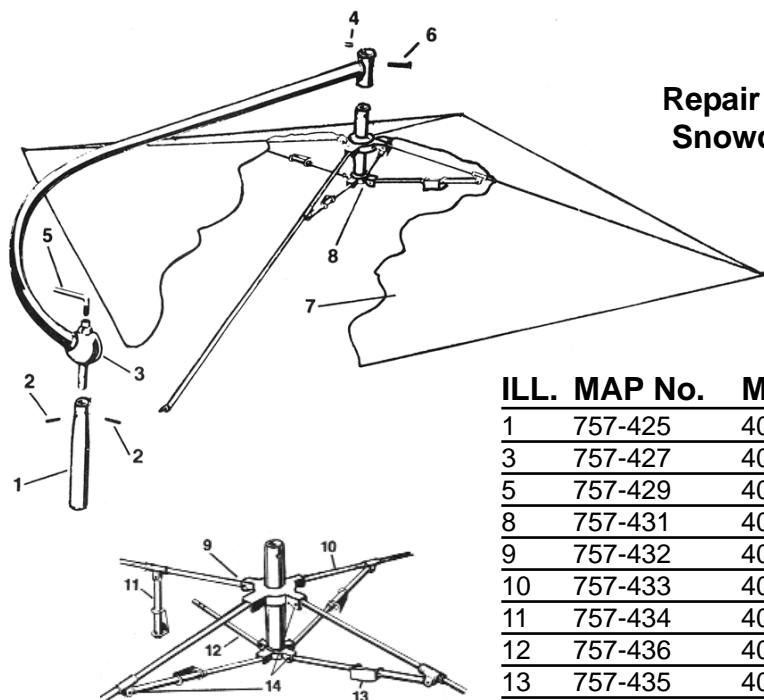

### Repair Parts List for Hammerblow - Snowco TU-56 Umbrellas

ILL.	MAP No.	Mfg.No	Description	Qty
1	757-425	405125	Support Shaft	1
3	757-427	405127	Curved Shaft	1
5	757-429	405129	Locking Handle	1
8	757-431	405131	Frame Assembly	1
9	757-432	405132	Center Spider Tube	1
10	757-433	405133	Bow w/ Clevis	4
11	757-434	405134	Push Rod Tube	4
12	757-436	405135	Push Rod	4
13	757-435	405140	Push Rod Clip	4
14	757-444	491176	Push Rod Rivet	12

Modern Ag Parts - Beaumont, Texas - Order Toll-Free 1-888-404-8908 - Fax Toll-Free 1-888-404-8910

## TRACTOR SEATS

For Case, Deutz, Fiat, Ford, International Harvester  
John Deere & Massey Ferguson

- \* Full suspension system (shock absorber & springs). Single knob adjustment.
- \* Super comfort cushioned individual seat bottom & seat covered in durable, good looking leather-like heavy gauge vinyl.
- \* Available in black, yellow, and blue to match many oem ag. & industrial applications.

**FITS FORD:** 2000, 3000, 4000, 5000, 7000,  
(1965 To 1975) 2600, 3600, 3900, 4100, 4600, 5600, 6600, 7600,  
(1975 To 1981) 2610, 2910, 3610, 3910, 4110, 4610, 5610, 5910, 6610, 7610,  
(1981 To-) Can Replace D6NN400P, D9NN400DB12B

**FITS JOHN DEERE:** 820, 830, 1020, 1530, 2020, 2030, 2040, 2150, 2155, 2240, 2350, 2355,  
2440, 2555, 2550, 2640, 2750, 2755, 2840, 2940, 2955

**FITS MASSEY FERGUSON:** 135, 150, 165, 175, 180, 185, 230, 235, 240, 245, 250, 254, 255,  
265, 270, 274, 275, 285, 290, 294, 550, 565, 575, 590, 595, 670, 675, 690, 698



### ECONOMY SEATS



PART NO.	COLOR
----------	-------

751-820	BLUE
751-821	YELLOW
751-822	BLACK
751-825	BLACK - TRAPEZOID BACK

Universal Slide Track - 5 Hole Adj. - Angle Base

### REPLACEMENT CUSHIONS FOR ECONOMY SEATS

PART NO.	COLOR / TYPE
751-840	BLACK / BACKREST (WAFFLE)
751-841	BLACK / CUSHION (WAFFLE)
751-842	BLUE / BACKREST (WAFFLE)
751-843	BLUE / CUSHION (WAFFLE)
751-844	YELLOW / BACKREST (WAFFLE)
751-845	YELLOW / CUSHION (WAFFLE)
751-846	BLACK / TRAP. BACKREST

### UNIVERSAL COMPACT TRACTOR SEAT



Width: 16-1/8"  
Depth: 19-1/8"

<b>PART NO.</b>	<b>PART NO.</b>
751-250	751-200
<u>Seat w/ Brackets</u>	<u>Seat Less Brackets</u>

**PART NO.**  
751-251  
Brackets

Modern Ag Parts - Beaumont, Texas - Order Toll-Free 1-888-404-8908 - Fax Toll-Free 1-888-404-8910

## TRACTOR SEATS

Replace worn out farm tractor seats with deluxe comfort ride seat with folding arm rest. Will fit same bolt pattern as existing seat-no drilling, cutting or welding.



**SPECIFICATION:**

MATERIAL: 40 Oz. Heavy Duty Naugahyde  
 FOAM: Full Depth High Density Molded  
 Fire Retardant Polyurethane  
 FRAME: 16 GA. Steel Tubing  
 With Black Enamel Finish  
 ARM REST: Fold-up type  
 WEIGHT: 29 lbs.

This seat assembly is ideally suited for John Deere and International Harvester farm equipment. Meets all federal motor vehicle safety standards contoured seat and back molded fire retardant foam 4" fore and aft adjustment. Functionally styled seat assembly will decrease fatigue and increase production.

**AVAILABLE IN  
BROWN, YELLOW, & BLACK**

**SEAT WILL FIT THE FOLLOWING:**  
**JOHN** 1010, 420c, 2010, 2510, 3010, 3020, 4010, 4020, 4030, 4230,  
**DEERE** 4320, 4430, 4520, 4620, 4630, 5010, 5020, 6030, 7020, 7520,  
 8430, 8630, Combines 3300, 4400, 6600, 6602, 7700  
**I H C** 460, 504, 660, 706, 756, 1206, 2706, 544, 560, 656, 806,  
 826, 856, 1026, 1066, 1466

PART NO.	MFG. NO.	COLOR
751-465	WM465B	BROWN
751-467	WM465Y	YELLOW
751-468	WM468	BLACK

### MODEL V560



NEW DESIGN FEATURING AIR CIRCULATION AND WATER DRAINAGE.

MOLDED CUSHION, DRAWN STEEL PAN WITH PROTECTIVE EDGE TRIM.

STANDARD PRODUCTION BLACK.

THIS SEAT IS ADAPTABLE TO THE FOLLOWING FORD MODELS: 9N, 2N, 8N, NAA, 600, 800, 900, 2000, 4000, (1939 © 64); 3000, 4000, 5000, (1965 ©).

**Part No.**

751-560

### STANDARD

## SEAT CUSHIONS

### REVERSIBLE

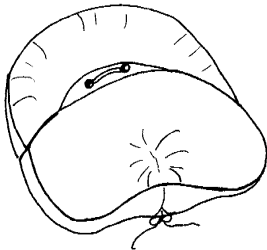

Part No.	Type
751-501	Red & White
751-502	Blue & White
*751-505	Reversible
751-508	Yellow



**QUALITY CUSHIONS FOR ALL STANDARD BUCKET-TYPE TRACTOR AND IMPLEMENT SEATS.**

- \*1. COVERING ONE SIDE OF BEAUTIFUL LEATHERETTE, FOR LONGER WEAR AND COLD WEATHER COMFORT...IN TU-TONE COMBINATION...ASSORTED COLORS.
- \*2. COVERING OTHER SIDE OF WATER-REPELLENT KHAKI DUCK FOR COOLER SERVICE.
3. SECTIONAL STITCHING, LOCKS CUSHIONING IN PLACE...NO CHANCE FOR SHIFTING, LUMPING UP OR MATTING DOWN.
4. FILLED WITH POLYURETHANE FOAM CUSHIONING MATERIAL.
5. EXTRA HEAVY PULL AND TIE CORDS...SECURED WITH BRASS GROMMETS. NO SLIPPING OR DISPLACEMENT.

Modern Ag Parts - Beaumont, Texas - Order Toll-Free 1-888-404-8908 - Fax Toll-Free 1-888-404-8910



ALLIS CHALMERS		CASE/INTERNATIONAL	
<p>MODELS: B, C, CA, G, RC, WC, WD, WD45, WD45DIESEL, WF <b>MAP NO. 848-1111 AC-11</b></p>		<p>MODELS: 235, 245, 255, 265, 275 <b>MAP No. 848-1242 G42</b></p>	
ALLIS CHALMERS COLLECTIONS		FORD	
<p>MODELS: D-14, D-15, SERIES II D-15, D-17, SERIES III D-17, SERIES IV D-17 MODELS: D-10, D-10 SERIES III, D-12, D-12 SERIES III MODEL 160 MODELS: 170, 175 <b>MAP NO. 848-1160 AC-201</b></p>		<p>SERIES 2N, 8N, 9N <b>MAP NO. 848-1404 FO-4</b></p>	
<p>MODELS: D-21, D-21 SERIES II, TWO-TEN, TWO-TWENTY MODELS: D-19, D-19 DIESEL MODELS: 7010, 7020, 7030, 7040, 7045, 7050, 7060, 7080 MODELS: 180, 185, 190XT, 200, 7000 <b>MAP NO. 848-1161 AC-202</b></p>		<p>MODEL NAA, Including the Golden Jubilee <b>MAP NO. 848-1419 FO-19</b></p>	
CASE/INTERNATIONAL		<p>SERIES 501, 600, 601, 700,701, 800, 801, 900, 901, 1801, 2000 (4 CYL.), 4000 (4 CYL.) <b>MAP NO. 848-1420 FO-20</b></p>	
<p>MODELS: 1190, 1194, 1290, 1294, 1390, 1394, 1490, 1494, 1594, 1690 <b>MAP NO. 848-1236 C-36</b></p>		<p>SERIES: 2000 (3-CYL), 3000 (3-CYL), 4000 (3-CYL), Covers models prior to 1975 <b>MAP NO. 848-1431 FO-31</b></p>	
<p>MODELS: 2090, 2094, 2290, 2294, 2390, 2394, 2590, 2594 <b>MAP NO. 848-1237 C-37</b></p>		<p>MODELS: 2310, 2600, 3600, 4100 (After 1974), 4110, 4600, 4610, (Prior to 1984), 4600SU, 2610, 3610, 4610SU (Prior to 1984) <b>MAP. NO. 848-1441 FO-41</b></p>	
<p>MODELS: 385, 485, 585, 685, 885 <b>MAP NO. 848-1239 C-39</b></p>		<p>SERIES: 5000, 5600, 5610, 6600, 6610, 6700, 6710, 7000, 7600, 7610, 7700, 7710 <b>MAP NO. 848-1442 FO-42</b></p>	
<p>MAGNUM MODELS: 7110, 7120, 7130, 7140 <b>MAP NO. 848-1240 C-40</b></p>		<p>SERIES: 2810, 2910, 3910 <b>MAP NO. 848-1443 FO-43</b></p>	
<p>MAXXUM MODELS: 5120, 5130, 5140 <b>MAP NO. 848-1241 C-41</b></p>		<p>SERIES: 1100, 1110, 1200, 1210, 1300, 1310, 1500, 1510, 1700, 1710, 1900, 1910, 2110 <b>MAP NO. 848-1444 FO-44</b></p>	

Modern Ag Parts - Beaumont, Texas - Order Toll-Free 1-888-404-8908 - Fax Toll-Free 1-888-404-8910



<b>FORD</b>	<b>JOHN DEERE</b>
SERIES: 1120, 1220, 1320, 1520, 1720, 1920, 2120 <b>MAP NO. 848-1446 FO-46</b>	SERIES: A, B, G, H MODELS: D, M, MT <b>MAP NO. 848-1304 JD-4</b>
MODELS: 3230, 3430, 3930, 4630, 4830 <b>MAP No. 848-1447 FO-47</b>	MODELS: 50, 60, 70 <b>MAP NO. 848-1310 JD-10</b>
<b>FORD COLLECTION</b>	SERIES: 520, 530, 620, 630, 720, 730 <b>MAP. NO. 848-1316 JD-16</b>
MODELS: Fordson Dexta, Fordson Super Dexta, 2000 Super Dexta, New Performance Super Dexta MODELS: Fordson Major Diesel (FMD), Fordson Power Major (FPM), Fordson Super Major (FSM), New Performance Fordson Super Major (NEW FSM), 5000 Super Major SERIES: 6000, Commander 6000 SERIES: 1000, 1600 SERIES: 8000, 8600, 8700, 9000, 9600, 9700, TW-10, TW-20, TW-30 <b>MAP NO. 848-1460 FO-201</b>	SERIES: 1010, 2010 <b>MAP NO. 848-1321 JD-21</b>
	SERIES: 1020, 1520, 1530, 2020, 2030 <b>MAP NO. 848-1337 JD-37</b>
	SERIES: 850, 950, 1050 <b>MAP NO. 848-1347 JD-47</b>
	SERIES: 4030, 4230, 4430, 4630 <b>MAP NO. 848-1350 JD-50</b>
<b>JI CASE COLLECTION</b>	MODELS: 2840, 2940, 2950 <b>MAP NO. 848-1356 JD-56</b>
SERIES: C, D, L, LA, R, S, V, VA, CC, CO, DC, DH, DO, DS, DV, RC, SC, SO, VO, VAC, VAO, VAH SERIES: 200B, 300, 300B, 350, 400B, 500B, 600B SERIES: 400, 700B, 800B <b>MAP NO. 848-1260 C-201</b>	MODELS: 4050, 4250, 4450, 4650, 4850 <b>MAP NO. 848-1357 JD-57</b>
SERIES: 500, 600, 900B SERIES: 730, 830, 930, 1030 SERIES: 430, 470, 530, 570, 630 <b>MAP NO. 848-1261 C-202</b>	MODELS: 2150, 2155, 2255, 2350, 2355, 2355N, 2550, 2555 <b>MAP NO. 848-1358 JD-58</b>
SERIES: 770, 870, 970, 1070, 1090, 1170, 1175 MODELS: 885, 995, 1210, 1212, 1410, 1412 MODELS: 770, 780, 880 (After Serial No. 52100), 990 (After Serial No. 467870), 1200, 3800, 1570 SERIES: 1270, 1370, 1570 <b>MAP NO. 848-1262 C-203</b>	MODELS: 2750, 2755, 2855, 2955 <b>MAP NO. 848-1363 JD-59</b>
	MODELS 1250, 1450, 1650 <b>MAP No. 848-1355 JD-55</b>

Modern Ag Parts - Beaumont, Texas - Order Toll-Free 1-888-404-8908 - Fax Toll-Free 1-888-404-8910



JOHN DEERE COLLECTION	INTERNATIONAL HARVESTER
<p>MODEL: 720 DIESEL, 730 DIESEL            SERIES: 40, 320, 330, 420, 430, 440            SERIES: 80, 820, 830 (Two Cylinder Diesel Models)            SERIES: 820, 830 (Three Cylinder Models)            SERIES: 435D, 440ID (Diesel Models)  <b>MAP NO. 848-1360 JD-201</b></p>	<p>MODELS: Int'l Cub 154 Lo-Boy, Int'l Cub 184 Lo-Boy, Int'l Cub 185 Lo-Boy, Farmall Cub, Int'l Cub, Int'l Cub Lo-Boy  <b>MAP NO. 848-1550 IH-50</b></p>
<p>SERIES: 2040            SERIES: 2510, 2520            SERIES: 2240, 2440, 2630, 2640            SERIES: 2840            SERIES: 4040, 4240, 4440, 4640, 4840  <b>MAP NO. 848-1362 JD-202</b></p>	<p>SERIES: 5088, 5288, 5488  <b>MAP NO. 848-1556 IH-56</b></p>
<p>SERIES: 6030            SERIES: 3020 (Serial No. 123000 and up), 4000, 4020 (Serial 201000 and up), 4320, 4520, 4620            SERIES: 3010, 3020 (Before Serial No. 123000), 4010, 4020 (Before Serial No. 201000), 5010, 5020  <b>MAP NO. 848-1361 JD-203</b></p>	<p>INTERNATIONAL HARVESTER COLLECTION            SERIES: 100, 130, 140, 200, 230, 240, 404, 2404, 330, 340, 504, 2504, B-275, B-414, 354, 364, 384, 424, 444, 2424, 2444  <b>MAP NO. 848-1561 IH-201</b></p>
<p style="background-color: black; color: white; text-align: center;"><b>INTERNATIONAL HARVESTER</b></p> <p>SUPER &amp; NON-SUPER            SERIES: A, B, C, MTA, H, M, MD, CUB (Prior to 1957), MTAD, 4, 6, D6, W6TA, W6TAD, 9, D9  <b>MAP NO. 848-1508 IH-8</b></p>	<p>SERIES: 544, 656, 666, 686, Hydro 70, Hydro 86, Hydro 100, 126, 1466, 1468, 1486, 1566, 1568, 1586, 684, 784, 884, Hydro 84  <b>MAP NO. 848-1560 IH-202</b></p>
<p>SERIES: 300, 300 Utility, 350, 350 Utility, 350D, 350D Utility, 400, 400D, W400, W400D, 450, 450D, W450, W450D  <b>MAP NO. 848-1510 IH-10</b></p>	<p>SERIES: 766, 826, 966, 1026, 1066, 454, 464, 484, 574, 584, 674, 786, 886, 986, 1086  <b>MAP NO. 848-1562 IH-203</b></p>
<p>SERIES: 460, 560, 606, 660, 2606  <b>MAP NO. 848-1525 IH-25</b></p>	<p style="background-color: black; color: white; text-align: center;"><b>MASSEY-FERGUSON</b></p> <p>MODELS: TE20, TO20, TO30  <b>MAP NO. 848-1602 FE-2</b></p>
<p>SERIES: 706, 756, 806, 856, 1206, 1256, 1456, 2706, 2756, 2806, 2856, 21206, 21256, 21456  <b>MAP NO. 848-1532 IH-32</b></p>	<p>MODELS: TO35, TO35 DIESEL, F40, MH50, MHF202, MF35, MF35 DIESEL, MF50, MF202, MF204  <b>MAP NO. 848-1614 MF-14</b></p>
	<p>MODELS: MF135, MF150, MF165  <b>MAP NO. 848-1627 MF-27</b></p>
	<p>MODEL: MF285  <b>MAP NO. 848-1636 MF-36</b></p>
	<p>MODELS: MF670, MF690, MF698  <b>MAP NO. 848-1641 MF-41</b></p>



Modern Ag Parts - Beaumont, Texas - Order Toll-Free 1-888-404-8908 - Fax Toll-Free 1-888-404-8910

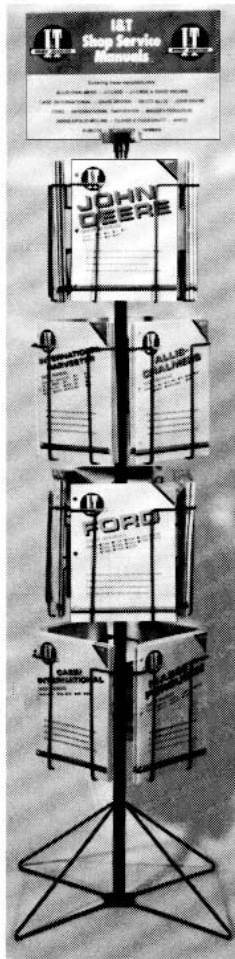
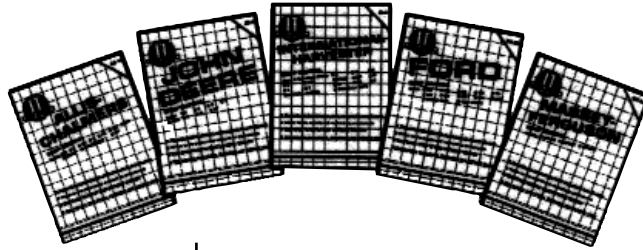

### I & T SERVICE MANUAL DISPLAY RACK

A great addition to your storefront to increase sales on I & T manuals. Takes up little space yet has 16 slots available for all types of manuals. Order 24 of the I & T manuals and receive an 848-1 at your request. Call customer service to find out how you can receive this rack free.

**MAP NO. 848-1**



### I & T SERVICE MANUAL DISPLAY RACK

This 20-pocket waterfall rack can be free-standing or hung on pegboard. Call our customer service department to find out how you can receive the rack free!

**MAP No. 848-2**

**3 PT. & TRACTOR ACCESSORIES**

Weathercaps

Muffler Clamps

Ford & Ferguson Muffler Clamp Kit

Modern Ag Parts - Beaumont, Texas - Order Toll-Free 1-888-404-8908 - Fax Toll-Free 1-888-404-8910

## WEATHERCAPS

**FULLY AUTOMATIC PROTECTION FOR ALL VERTICAL EXHAUST STACKS**

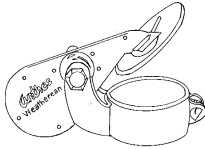

PART NO.	MIN. O.D.	MAX. O.D.	PART NO.	MIN. O.D.	MAX. O.D.
367-0	1"	1-3/16"	367-10	3-1/2"	3-11/16"
367-1	1-1/4"	1-7/16"	367-11	3-3/4"	3-15/16"
367-2	1-1/2"	1-11/16"	367-12	4"	4-3/16"
367-3	1-3/4"	1-15/16"	367-13	4-1/4"	4-7/16"
367-4	2"	2-3/16"	367-14	4-1/2"	4-11/16"
367-5	2-1/4"	2-7/16"	367-15	4-3/4"	4-15/16"
367-6	2-1/2"	2-11/16"	367-16	5"	5-3/16"
367-7	2-3/4"	2-15/16"	367-17	5-1/4"	5-7/16"
367-8	3"	3-3/16"	367-18	5-1/2"	5-11/16"
367-9	3-1/4"	3-7/16"	367-20	6"	6-1/8"

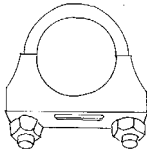

### MUFFLER CLAMPS

STANDARD 5/16" U BOLT		HEAVY DUTY 3/8" U BOLT	
PART NO.	SIZE	PART NO.	SIZE
654-1044	1-1/8"	654-1060	1-7/8"
654-1046	1-1/4"	654-1064	2"
654-1048	1-1/2"	654-1065	2-1/8"
654-1050	1-5/8"	654-1066	2-1/4"
654-1056	1-3/4"	654-1068	2-1/2"
654-1057	1-7/8"	654-1070	2-3/4"
654-1058	2"	654-1072	3"
654-1059	2-1/8"	654-1074	3-1/2"
654-1061	2-1/4"	654-1076	4"
654-1062	2-1/2"	654-1078	4-1/2"
		654-1080	5"

### FORD & FERGUSON MUFFLER CLAMP KIT

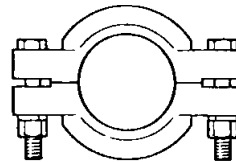

**PART NO.**  
654-1189

FOR MODELS: FORD 2N, 8N, 9N,  
MASSEY TO 20, 30.  
CONTAINS: 2 CLAMPS, 2 NUTS,  
2 BOLTS & LOCKWASHERS

# QUALITY & MODERN:

## *OUR PERSONAL COMMITMENT*

**Providing Customer Satisfaction,  
Competitive Prices, Quality Products  
And Service You Can Rely Upon Since 1963.**

**3 PT. & TRACTOR ACCESSORIES**

Donaldson Pre-Cleaners Complete  
 Replacement Bowls for Donaldson Pre-Cleaners  
 Donaldson Pre-Cleaner Cross Reference

Modern Ag Parts - Beaumont, Texas - Order Toll-Free 1-888-404-8908 - Fax Toll-Free 1-888-404-8910

## DONALDSON PRE-CLEANERS COMPLETE

PART NO.	DONALDSON NO.	TO FIT INLET TUBE O.D.	DIMENSION A
355-3	H000213	2	5-19/32
355-5	H001250	2-1/4	7-11/32
355-6	H001251	2-1/2	7-11/32
355-7	H001249	3	7-11/32
355-8	H000820	3 *	10-5/8
355-10	H000858	4	10-5/8
355-12	H000823	4-1/2	10-5/8

\* HEAVY DUTY PRE-CLEANER

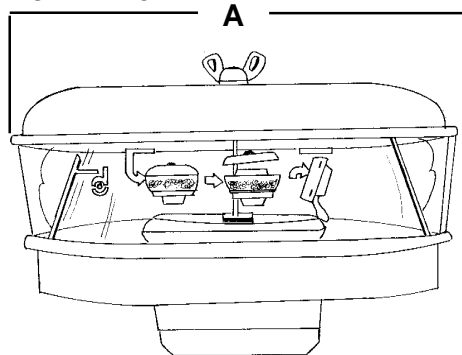

## REPLACEMENT BOWLS FOR DONALDSON PRE-CLEANERS

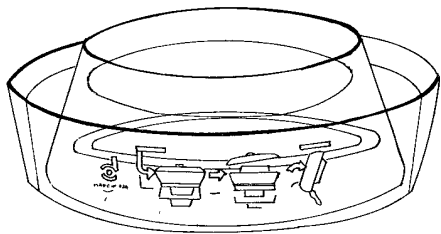

PART NO.	DONALDSON NO.	TO FIT PRE-CLEANER ABOVE
355-400	P02-0115	355-3
355-402	P02-0227	355-5
355-402	P02-0227	355-6
355-402	P02-0227	355-7
355-403	P01-6330	355-8
355-403	P01-6330	355-10
355-403	P01-6330	355-12

## DONALDSON PRE-CLEANER CROSS REFERENCE

M.A.P. BOWL #	FOR FORD		FOR JOHN DEERE	
	REPLACES BOWL #	FITS MODELS	REPLACES BOWL #	FITS MODELS
355-400	FORD # B9NN9A663A	2000-5000	-----	-----
	DONALDSON # P02-0115			
355-402	FORD # CONN9A663A	2000-5000	JOHN DEERE # R28794	2010, 2510, 3010, 3020
	DONALDSON # P02-0344			
355-403	FORD # C9NN9A663A	7000	JOHN DEERE # R28795	4010, 4020, 5010, 5020
	DONALDSON # P02-0227			

Modern Ag Parts - Beaumont, Texas - Order Toll-Free 1-888-404-8908 - Fax Toll-Free 1-888-404-8910

## MINIATURE BULBS / LAMPS

PLEASE ORDER IN MULTIPLES OF 10

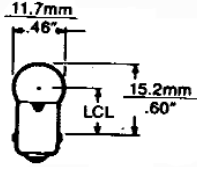
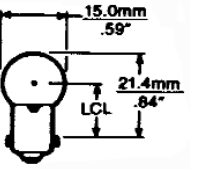
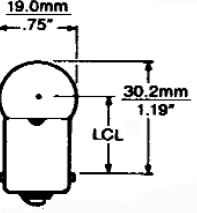
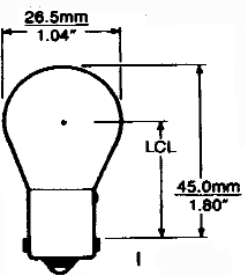
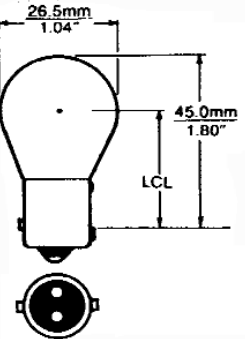
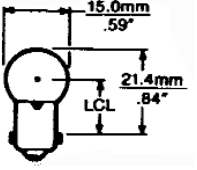
 <p><b>752-4501</b></p>	<table border="1"> <thead> <tr> <th>PART NO.</th> <th>DESCRIPTION</th> </tr> </thead> <tbody> <tr> <td>752-4501</td> <td>#53 MINIATURE LAMP</td> </tr> <tr> <td colspan="2">APPLICATION: INDICATOR, INSTRUMENT</td> </tr> </tbody> </table>	PART NO.	DESCRIPTION	752-4501	#53 MINIATURE LAMP	APPLICATION: INDICATOR, INSTRUMENT							
PART NO.	DESCRIPTION												
752-4501	#53 MINIATURE LAMP												
APPLICATION: INDICATOR, INSTRUMENT													
 <p><b>752-4502</b></p>	<table border="1"> <thead> <tr> <th>PART NO.</th> <th>DESCRIPTION</th> </tr> </thead> <tbody> <tr> <td>752-4502</td> <td>#57 MINIATURE LAMP</td> </tr> <tr> <td colspan="2">APPLICATION: INDICATOR, INSTRUMENT, MARKER</td> </tr> </tbody> </table>	PART NO.	DESCRIPTION	752-4502	#57 MINIATURE LAMP	APPLICATION: INDICATOR, INSTRUMENT, MARKER							
PART NO.	DESCRIPTION												
752-4502	#57 MINIATURE LAMP												
APPLICATION: INDICATOR, INSTRUMENT, MARKER													
 <p><b>752-4503</b></p>	<table border="1"> <thead> <tr> <th>PART NO.</th> <th>DESCRIPTION</th> </tr> </thead> <tbody> <tr> <td>752-4503</td> <td>#67 MINIATURE LAMP</td> </tr> <tr> <td colspan="2">APPLICATION: LICENSE, PARK, MARKER</td> </tr> </tbody> </table>	PART NO.	DESCRIPTION	752-4503	#67 MINIATURE LAMP	APPLICATION: LICENSE, PARK, MARKER							
PART NO.	DESCRIPTION												
752-4503	#67 MINIATURE LAMP												
APPLICATION: LICENSE, PARK, MARKER													
 <p><b>752-4504</b></p>	<table border="1"> <thead> <tr> <th>PART NO.</th> <th>DESCRIPTION</th> </tr> </thead> <tbody> <tr> <td>752-4504</td> <td>#1156 MINIATURE LAMP</td> </tr> <tr> <td colspan="2">APPLICATION: HEAVY DUTY TURN SIGNAL</td> </tr> </tbody> </table>	PART NO.	DESCRIPTION	752-4504	#1156 MINIATURE LAMP	APPLICATION: HEAVY DUTY TURN SIGNAL							
PART NO.	DESCRIPTION												
752-4504	#1156 MINIATURE LAMP												
APPLICATION: HEAVY DUTY TURN SIGNAL													
 <p><b>752-4505</b></p>	<table border="1"> <thead> <tr> <th>PART NO.</th> <th>DESCRIPTION</th> </tr> </thead> <tbody> <tr> <td>752-4505</td> <td>#1157 MINIATURE LAMP</td> </tr> <tr> <td colspan="2">APPLICATION: HEAVY DUTY TURN SIGNAL, PARK</td> </tr> <tr> <th>PART NO.</th> <th>DESCRIPTION</th> </tr> <tr> <td>752-4506</td> <td>#1895 MINIATURE LAMP</td> </tr> <tr> <td colspan="2">APPLICATION: HEAVY DUTY MARKER, INSTRUMENT, INDICATOR</td> </tr> </tbody> </table>	PART NO.	DESCRIPTION	752-4505	#1157 MINIATURE LAMP	APPLICATION: HEAVY DUTY TURN SIGNAL, PARK		PART NO.	DESCRIPTION	752-4506	#1895 MINIATURE LAMP	APPLICATION: HEAVY DUTY MARKER, INSTRUMENT, INDICATOR	
PART NO.	DESCRIPTION												
752-4505	#1157 MINIATURE LAMP												
APPLICATION: HEAVY DUTY TURN SIGNAL, PARK													
PART NO.	DESCRIPTION												
752-4506	#1895 MINIATURE LAMP												
APPLICATION: HEAVY DUTY MARKER, INSTRUMENT, INDICATOR													
 <p><b>752-4506</b></p>	<table border="1"> <thead> <tr> <th>PART NO.</th> <th>DESCRIPTION</th> </tr> </thead> <tbody> <tr> <td>752-4507</td> <td>#1073 MINIATURE LAMP</td> </tr> <tr> <td colspan="2">APPLICATION: TURN SIGNAL</td> </tr> <tr> <td colspan="2">Same picture as 752-4504. Dimensions not available.</td> </tr> </tbody> </table>	PART NO.	DESCRIPTION	752-4507	#1073 MINIATURE LAMP	APPLICATION: TURN SIGNAL		Same picture as 752-4504. Dimensions not available.					
PART NO.	DESCRIPTION												
752-4507	#1073 MINIATURE LAMP												
APPLICATION: TURN SIGNAL													
Same picture as 752-4504. Dimensions not available.													

Modern Ag Parts - Beaumont, Texas - Order Toll-Free 1-888-404-8908 - Fax Toll-Free 1-888-404-8910

## TRACTOR LIGHTS

### HEAVY DUTY RECTANGULAR HALOGEN TRACTOR LAMP



**FOR OFF THE ROAD USE ONLY.**

**FEATURES:**

- LONGER BULB LIFE, 400 HR. AVERAGE
- EASILY REPLACEABLE BEAM
- 12 VOLT- 50 WATT
- ADJUSTABLE
- EXTRA LARGE 4" X 6"
- EASY SWIVEL MOUNT
- FIELD TESTED UNDER EXTREME CONDITIONS
- HIGHER LIGHT OUTPUT (UP TO 200,000 CANDLE POWER)
- LAB TESTED TO 6 G'S VIBRATION
- ILLUMINATES 60 FT. WIDE IMPLEMENTS

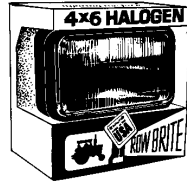

**PART NO. DESCRIPTION**

- 752-2001 FLOOD LIGHT
- 752-2002 TRAPEZOID LIGHT
- 752-2003 SPOT LIGHT

**REPLACEMENT SEAL BEAMS**

**PART NO. DESCRIPTION**

- 752-2050 FLOOD LIGHT
- 752-2051 TRAPEZOID LIGHT
- 752-2052 SPOT LIGHT

### 3 X 5 RECTANGULAR HALOGEN SEALED BEAM LAMP

**FEATURES:**

- BOROSILICATE GLASS LENS RESISTS CRACKING AND WARPAGE, AND PREVENTS DISTORTION AND LENS DISCOLORATION. SEALED BEAM (12 VOLT - 50 WATT) CONSTRUCTION ASSURES MAXIMUM LIGHTING OUTPUT BY PREVENTING CONTAMINATION OVER THE LIFE OF THE LAMP. RUST-RESISTANT HEAVY-DUTY SWIVEL MOUNTING HARDWARE. HIGH-IMPACT POLYPROPYLENE LAMP HOUSING.

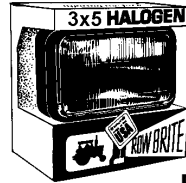

**FOR OFF THE ROAD USE ONLY.**

**PART NO. DESCRIPTION**

- 752-2007 FLOOD LIGHT
- 752-2008 TRAPEZOID LIGHT

## HALOGEN RECTANGULAR LIGHTS

### BLAZER 3 X 5

BLAZER 3 x 5 HALOGEN MINI TRACTOR LIGHTS FEATURE A POLYPROPYLENE HOUSING, AND UNIVERSAL REAR MOUNTING. THE LIGHTS ARE 12 VOLT WITH A 55 WATT H-3 HALOGEN BULB.

**PART NO. DESCRIPTION**

- 752-3322 FLOOD BEAM PATTERN
- 752-3323 TRAPEZOIDAL UTILITY BEAM PATTERN

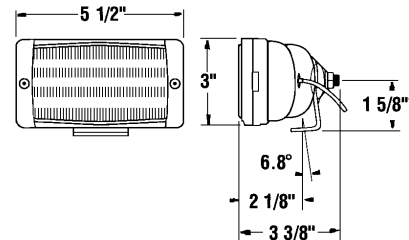

### BLAZER 4 X 6

BLAZER 4 x 6 HALOGEN TRACTOR LIGHTS FEATURE A CORROSION RESISTANT MOLDED HOUSING WITH FACE GUARDS, AND HEAVY DUTY ADJUSTABLE MOUNTING HARDWARE FOR EASY INSTALLATION. THE LIGHTS ARE 12 VOLT WITH A 55 WATT H-3 HALOGEN BULB. MADE FOR USE ON ALL IMPLEMENT VEHICLES.

**PART NO. DESCRIPTION**

- 752-3301 FLOOD BEAM PATTERN
- 752-3302 TRAPEZOIDAL UTILITY BEAM PATTERN
- 752-3303 SPOT BEAM PATTERN

**PART NO. DESCRIPTION**

- 752-3405 REPLACEMENT HALOGEN BULB #H-3, 12V-55W

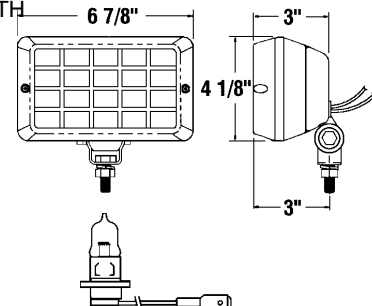

**3 PT. & TRACTOR ACCESSORIES**

Tractor Lights  
Magnetic Base Worklight

Modern Ag Parts - Beaumont, Texas - Order Toll-Free 1-888-404-8908 - Fax Toll-Free 1-888-404-8910

## TRACTOR LIGHTS



### 3 X 5 HALOGEN LAMP WITH BUILT-IN SWITCH



- SPECIFICATIONS: 12 VDC • 50 WATTS
- ADJUSTABLE EASY SWIVEL MOUNT
- SHOCK AND VIBRATION RESISTANT
- HIGH-INTENSITY LAMP (NOT LEGAL FOR STREET USE)
- HEAVY-DUTY, RUST RESISTANT MOUNTING BRACKET
- AVAILABLE ONLY IN 3 X 5 FLOOD

**PART NO.**      **MFG. NO.**  
752-2005      77861-49

#### REPLACEMENT LAMP

**PART NO.**  
752-2006

### STANDARD INCANDESCENT UTILITY LAMPS FOR FARM AND CONSTRUCTION EQUIPMENT BLAZER VEHICLE WORK AND UTILITY LIGHT

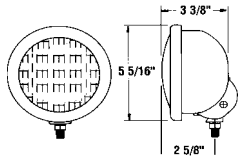

- STEEL HOUSING WITH RUBBER BULB HOLDER
- PAR 36 INCANDESCENT BULB
- UNIVERSAL SINGLE STUD MOUNTING
- IDEAL FOR FARM IMPLEMENT VEHICLES

PART NO.	VOLT	DESCRIPTION
752-3320	6	PAR 36 LIGHT
752-3370	12	PAR 36 LIGHT

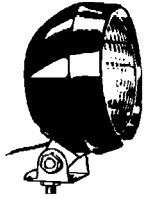

#### ALL WEATHER "RUBBER HOUSING" LIGHT

- ALL-WEATHER RUBBER HOUSING CUSHIONS SEALED BEAM (#4411) AGAINST VIBRATION.
- HOUSING IS RUST-FREE, WON'T SCRATCH OR DENT.
- MULTI-USE HOUSING ACCEPTS ALL PAR 36 HALOGEN OR STANDARD SEALED BEAM LAMPS.
- FULLY ADJUSTABLE BRACKET MOUNTS EASILY AND FIRMLY ON VIRTUALLY ANY CONTOUR.

PART NO.	VOLT	DESCRIPTION
752-3705	12	RUBBER UTILITY LAMP

## MAGNETIC BASE WORKLIGHT

SERVICE-MATE SM2262™

**FEATURES:**

- FLOOD LIGHT PATTERN, WITH 90° VERTICAL ADJUSTMENT.
- PLASTIC CAP ON A LARGE MAGNET BASE FOR SCRATCH PROTECTION.
- EASILY REPLACEABLE 55 WATT HALOGEN H-3 BULB.
- 12 FOOT CORD WITH CIGARETTE LIGHT PLUG.
- 12VDC OPERATION STANDARD. CONVERTS TO 24VDC USE BY REPLACING EXISTING BULB WITH 24V H-3 BULB.
- TWO-YEAR LIMITED WARRANTY AGAINST MANUFACTURER'S DEFECTS (EXCEPT FOR BULB).



PART NO.	DESCRIPTION
752-4001	Pt #15-ADP: 15 Foot Adapter Cords with Battery Clips.

**PART NO.**  
752-4000

### HALOGEN SEALED BEAM



PART NO.	REPLACES	DESCRIPTION	DIA.	TERMINAL
752-2060	H7606	12V FLOOD	4-1/2"	2 SCREW
752-3908	H7610	12V TRAPEZOIDAL	4-1/2"	2 SCREW

### SEALED BEAM

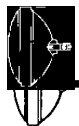

PART NO.	REPLACES	DESCRIPTION	DIA.	TERMINAL
752-3901	4406	12VOLT FLOOD	4-1/2"	2 SCREW
752-3902	4460X	12VOLT	4-1/2"	3 SCREW
752-3903	4511	6VOLT TRAPEZIODAL	4-1/2"	2 SCREW
752-3904	4019	6VOLT (PAR 46)	5-3/4"	2 SCREW
752-3905	4422	12VOLT	4-1/2"	2 SCREW
752-3906	4509	12VOLT 110,000 CANDLE POWER	4-1/2"	2 SCREW
752-3907	4440X	12VOLT	4-1/2"	3 PRONG
752-4411	4411	12VOLT TRAPEZIODAL (PAR 36)	4-1/2"	2 SCREW
752-4419	4419	12VOLT (PAR 46)	5-3/4"	2 SCREW

Modern Ag Parts - Beaumont, Texas - Order Toll-Free 1-888-404-8908 - Fax Toll-Free 1-888-404-8910

## HAZARD FLASHER

- Battery Operated
- Powerful Magnetic Base
- One Mile Visibility
- No Hook Up, Assembly or Wiring
- Use on Farm Equipment, Trucks, Cars, Tractors, RV's, Boats and Trailers
- Requires 4 AA Batteries
- Alternative for Flares

SAFETY HAZARD FLASHER THAT HELPS WARN OTHERS OF SLOW MOVING OR STOPPED VEHICLES ONLY WHEN YOU NEED IT.

MEETS DEPARTMENT OF TRANSPORTATION STANDARDS

<b>PART NO.</b>	<b>MODEL NO</b>	<b>COLOR</b>
752-5000	HF100A	RED/AMBER



## TOWING LIGHTS

THE ONLY TOWING PACKAGE THAT REALLY PULLS ITS OWN WEIGHT FEATURING BRAKE SIGNALS, TURN SIGNALS, TAIL LIGHT, AND EMERGENCY FLASHERS ALL IN ONE.

- For use in RV's With Car in Tow, Trailers, Boats in Tow, any General Towing
- Standard Features Include a Powerful Non-scratch Magnetic Base and 20' Cord Wiring Harness With Easy-to-use Directions
- 12 Volt System Easily Connects to any Standard Automobile Lighting System in Minutes

RED COLOR

MEETS DEPARTMENT OF TRANSPORTATION STANDARDS

<b>PART NO.</b>	<b>MODEL NO</b>
752-5001	ATL20A

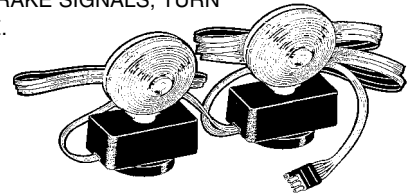

## SAFETY FLASHERS

"EXCEEDS DEPARTMENT OF TRANSPORTATION HIGHWAY STANDARDS"

- Powerful Magnetic Base
- Fits any Standard 12 volt cigarette Lighter (Battery Adapter Optional)
- 50 Foot Cord Length
- Highly Visible Amber and Red Lenses Can be Seen for Miles
- Farm & Heavy Equipment
- Emergency & Slow Moving Vehicles

RED / AMBER COLOR

<b>PART NO.</b>	<b>MODEL NO</b>
752-5002	EF12V50A

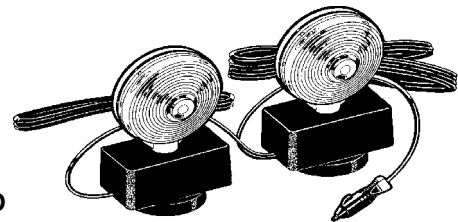

## ELECTRICAL SWITCHES

### PULL SWITCH

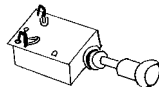

Off-On 15 Amps 12 Volt DC, Switch is "ON" when pulled out, 1/2" hole mount.

**PART NO.**  
374-2401

## WARNING / SAFETY LIGHT

<b>PART NO.</b>	<b>VOLT</b>	<b>DESCRIPTION</b>
752-5042	12	7/16" Hollow Stud Mounting w/ 2 Amber Lenses

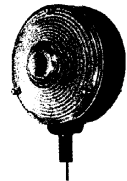

### MINIATURE TOGGLE



Single pole, double throw w/ Nickel plated handle.

Mounts through 1/4" hole.

**PART NO.**  
374-2405

### HEAVY DUTY CHROME TOGGLE



Die-cast body with extra long handle, 35 amp

**PART NO.**  
374-2403

### BRASS TOGGLE

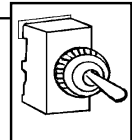

Heavy Duty rust proof, 20 amp On-Off for automotive, marine & RV applications.

**PART NO.**  
374-2402

Modern Ag Parts - Beaumont, Texas - Order Toll-Free 1-888-404-8908 - Fax Toll-Free 1-888-404-8910



## ENGINE HEATERS

SAVE WEAR & TEAR ON YOUR ENGINE

### MAGNETIC HEATERS

CAN BE USED ON OIL PAN, INTAKE MANIFOLD, BATTERY HOLDER, ENG. BLOCK, FOR THAWING FROZEN PIPES, LOCKS, ETC.  
 HEAT OUTPUT: 300° @ 400°F.



PART NO.	DESCRIPTION
395-100	110V AC, 200W, Heating Area: approx. 8 sq. inches.
395-101	110V AC, 300W, Heating Area: approx. 20 sq. inches.

### DIP STICK HEATER



PART NO.	DESCRIPTION
395-150	◎ 90 WATTS, 120 VOLTS, LENGTH: 24" ◎ STAINLESS STEEL TUBING, FITS MOST OIL STICK OPENINGS OF 1/4" OR MORE. ◎ HEATS OIL & AIR IN CRANKCASE - ECONOMICAL TO OPERATE.

### TANK TYPE ENGINE HEATERS

TANK HEATERS INSTALL READILY ON MOST LIQUID COOLED ENGINES. EACH HEATER IS THERMOSTATICALLY CONTROLLED FOR MAXIMUM ENERGY EFFICIENCY PERFORMANCE.

- Corrosion Resistant Interior Coating
- All Parts Included Except Heater Hose
- 3-Wire Heavy Duty Gauge
- Heat Resistant Cord
- Thermostatically Controlled
- 16 Gauge Steel Constructed

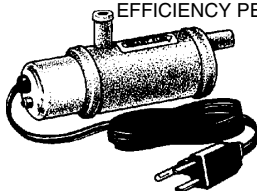

PART NO.	DESCRIPTION
395-200	120V AC, 850W, 7.0 Amps, 18 qt. capacity
395-201	120V AC, 1000W, 8.3 Amps, 16 @ 25 qt. capacity
395-202	120V AC, 1500W, 12.5 Amps, 26 @ 40 qt. capacity

### FROST PLUG HEATERS

THE FROST PLUG HEATER IS THE MOST EFFICIENT TYPE OF ENGINE HEATER AVAILABLE. FORGED BRASS BODY; POSITIVE LOCKING ASSEMBLY, O RING SEAL, LONG LIFE.

INSTALLS DIRECTLY INTO ENGINE BLOCK.



395-300



All Others

PART NO.	DESCRIPTION
395-300	3/4" NPT. plug, 120V AC, 400W
395-301	Replacement cord for 395-300.
395-307	1-1/4" dia. plug, 120V AC, 750W
395-302	1-1/2" dia. plug, 120V AC, 600W
395-303	1-5/8" dia. plug, 120V AC, 600W
395-304	1-3/4" dia. plug, 120V AC, 600W
395-305	2" dia. plug, 120V AC, 600W
395-306	2" dia. plug, 120V AC, 1000W

### LOWER RADIATOR HOSE HEATERS

THE LOWER RADIATOR HOSE HEATER IS A VERY EFFICIENT METHOD OF WARMING AN ENGINE. DESIGNED FOR ALL NIGHT OPERATION. THIS THERMOSTATICALLY CONTROLLED HEATERS WILL ALLOW EASY STARTING ON THE COLDEST WINTER MORNING.

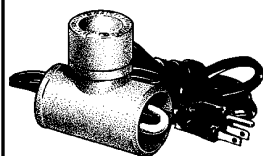

Hose Clamps  
 Included

PART NO.	DESCRIPTION
395-400	120V AC, 600W for 1-1/4" dia. hose.
395-401	120V AC, 600W for 1-1/2" dia. hose.
395-402	120V AC, 600W for 1-3/4" dia. hose.
395-403	120V AC, 600W for 2" dia. hose.

Modern Ag Parts - Beaumont, Texas - Order Toll-Free 1-888-404-8908 - Fax Toll-Free 1-888-404-8910

## BOOSTER CABLES



SIBERIAN TANGLE-FREE CONSTRUCTION REMAINS FLEXIBLE IN -45 DEGREE WEATHER. INSULATION PROVIDES TOP RESISTANCE TO ABRASION, CUTTING, AND DEFORMATION. 500 AMP COLOR CODED PARROT CLAMPS ARE COATED WITH HARD POLYVINYL CHORIDE TO RESIST ACID.

PART NO.	LENGTH	GAUGE
374-2151	12 FT.	4
374-2156	16 FT.	4

## BATTERY TOOLS

### TERMINAL LIFTER

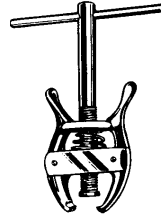

**BATTERY TERMINAL LIFTER**  
REMOVES EVEN THE MOST BADLY CORRODED BATTERY TERMINALS.

**PART NO.**  
374-827

### TERMINAL SPREADER



**PART NO.**  
374-828

## BOOSTER CABLE CLAMPS

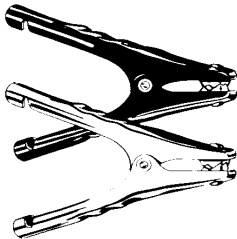

400 AMP SUPER CLAMP VINYL COATED, FULLY INSULATED COLOR CODED ORANGE AND BLACK.

**PART NO. PACKED**  
374-2144 1 PAIR PER PKG.

### POST CLEANER

**CLEAN BRUSH (STEEL)**

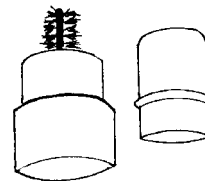

CONTAINS 2 WIRE BRUSHES, FOR BATTERY POSTS AND CABLE TERMINALS.

**PART NO.**  
374-829



**DESCRIPTION**  
500 AMP BOOSTER CABLE CLAMP (1 PAIR PER CARD)

**PART NO.**  
374-830

### 50 AMP BATTERY CLAMPS



SOLID COPPER BATTERY CLAMPS COMPLETE WITH VINYL PLASTIC HANDLE GUARDS. 50 AMPS. 1 PAIR IN A CLAM SHELL

**PART NO.**  
374-2075

## ALLIGATOR CLIPS

### SMALL ALLIGATOR



**PART NO.**  
374-2610

Priced Each

### LARGE ALLIGATOR



**PART NO.**  
374-2611

Priced Each

**3 PT. & TRACTOR ACCESSORIES**

Battery Cables, Starter Cables

Starter to Switch, Battery Terminals

Battery Jumpers, Ground Straps, Battery Bolts, Battery Cable Display

Modern Ag Parts - Beaumont, Texas - Order Toll-Free 1-888-404-8908 - Fax Toll-Free 1-888-404-8910

### BATTERY CABLES



**1 GAUGE COPPER WIRE LEAD TERMINAL**

PART NO.	LENGTH	PART NO.	LENGTH
374-1281	10"	374-1289	38"
374-1282	14"	374-1290	42"
374-1283	17"	374-1291	48"
374-1284	19"	374-1292	53"
374-1285	24"	374-1293	58"
374-1286	27"	374-1294	65"
374-1287	31"	374-1295	72"
374-1288	34"		

### STARTER CABLE



BARE COPPER STRANDED CONDUCTOR, COVERED WITH TOUGH POLYVINYL CHLORIDE INSULATION. THE THICK JACKET IS EASY TO STRIP, RESISTANT TO MOISTURE, WEATHER, OIL AND ACIDS.

PART NO.	SIZE	STRANDING	O.D.
374-2004	4 GA. X 25FT.	49X21	3/8"

### STARTER TO SWITCH

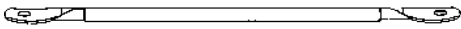

**2 GAUGE**

PART NO.	LENGTH	CAT.NO.	LENGTH
374-2409	9"	374-2438	38"
374-2415	15"	374-2444	44"

### BATTERY TERMINALS

**SOLDERLESS BATTERY TERMINALS**

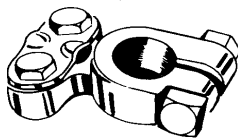

**PART NO. GAUGE**  
374-804 4

SOLD 10 PER CARD  
PRICED EACH

**HEAVY DUTY-UNIVERSAL EMERGENCY TERMINALS FOR TOP POST BATTERIES**

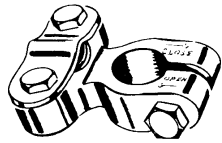

**PART NO. GAUGE**  
374-890 0

SOLD 10 PER CARD  
PRICED EACH

### BATTERY JUMPERS



BATTERY JUMPER CABLES WITH LEAD TERMINALS

PART NO.	LENGTH	PART NO.	LENGTH
374-1813	12"	374-1815	24"
374-1814	19"	374-1816	36"

### EMERGENCY TYPE-SIDE MOUNT



PART NO.	BOLT SIZE
374-838	3/8"

SOLD 8 PER CARD  
PRICED EACH

### GROUND STRAPS



**6 OR 12V BATTERY GROUND STRAPS 4 GA.**

PART NO.	LENGTH	PART NO.	LENGTH
374-1707	6-1/2"	374-1716	16"
374-1709	9"	374-1719	19"
374-1711	11"	374-1724	24"
374-1713	14"	374-1727	27"

### BATTERY BOLTS

WITH NUTS

5/16 - 18 X 1-1/4"

**PART NO.**  
**374-801**

SOLD 50 PER BAG



PRICED EACH

### BATTERY CABLE DISPLAY



**PART NO.**  
**374-2**

- 12 HOOKS
- HOLDS AT LEAST 36 CABLES
- FOR STORE DISPLAY OR SHOP USE

Modern Ag Parts - Beaumont, Texas - Order Toll-Free 1-888-404-8908 - Fax Toll-Free 1-888-404-8910

## PRIMARY WIRE

THE BASIC WIRE FOR AUTOS, TRUCKS AND NUMEROUS OTHER WIRING PROJECTS. VIVIDLY COLORED VINYL INSULATION OF FLEXIBLE STRANDED COPPER.

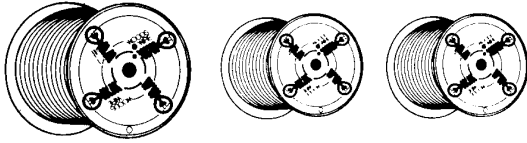

PART NO.	GAUGE	COLOR	FT PER SPOOL
374-213	16	RED	100
374-223	16	BLACK	100
374-271	16	YELLOW	28
374-313	14	RED	100
374-323	14	BLACK	100
374-351	14	GREEN	20
374-371	14	YELLOW	20
374-413	12	RED	100
374-423	12	BLACK	100
374-470	12	YELLOW	12

## DROP LIGHTS

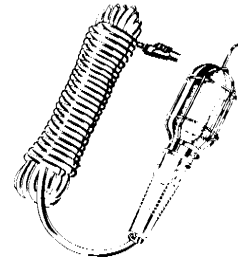

MEETS OSHA REQUIREMENTS FOR GENERAL USE. CORD IS CONSTRUCTED WITH EXTRA FLEXIBLE COPPER CONDUCTORS. OIL, ACID, ABRASION RESISTANT THERMO-PLASTIC JACKET. RUBBER HANDLE WITH PUSH THRU SWITCH. 3 WIRE LITE HANDLES HAVE ONE U-BLADE OUTLET. UL TYPE CORD AND REPLACEABLE PARTS USED.

PART NO.	GAUGE	LENGTH
374-1913	16	25
374-1914	16	50

## CRIMP TOOL

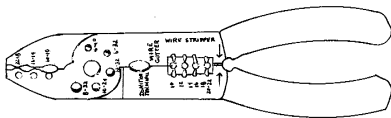

CRIMPS INSULATED AND UNINSULATED TERMINALS & SPLICES. TEMPERED ALLOY STEEL RESISTS WEATHER. MOLDED CUSHION GRIP, VINYL CLAD HANDLES. ALL-PURPOSE CONNECTOR TOOL. CRIMPS TERMINALS AND SPLICES, STRIPS AND CUTS WIRE, CUTS AND RETHREADS BOLTS. CRIMPS 7MM IGNITION WIRES.

PART NO.
374-853

## POWER CORDS

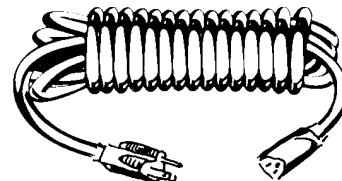

MEETS OSHA SPECS FOR OUTDOOR AND INDOOR USE INDIVIDUALLY PACKAGED IN ATTRACTIVE POLYETHYLENE BAGS. CONSTRUCTED WITH U.L. TYPE THERMOPLASTIC CORD AND WITH EXTRA FLEXIBLE COPPER CONDUCTORS. PLUGS AND SOCKETS ALSO MEET U.L. SPECIFICATIONS.

PART NO.	GAUGE/ WIRES	LENGTH
374-1903	16/3	25 FT.
374-1904	16/3	50 FT.

## 6 - 12 VOLT CIRCUIT TESTER



FEATURING THE MICRO-SHARP TIP FOR EASY WIRE PIERCING - WITHOUT WIRE DAMAGE. LEAVES VIRTUALLY A SELF-SEALING HOLE. INCLUDES THE ILLUSTRATED ELECTRICAL TROUBLE-SHOOTER'S GUIDE - A HANDY BOOKLET FOR BEGINNERS AND EXPERTS ALIKE; COVERS PRACTICAL CIRCUIT TESTER APPLICATIONS AND TROUBLESHOOTING TIPS. OVERALL LENGTH 36".

PART NO.
811-1232

3 PT. & TRACTOR ACCESSORIES

AGC Glass Fuses

SFE Glass Fuses

ATC Blade Fuses

Modern Ag Parts - Beaumont, Texas - Order Toll-Free 1-888-404-8908 - Fax Toll-Free 1-888-404-8910

# Buss® Fuses

Bussman is the largest fuse manufacturer in the world, with more than 20,000 different catalog numbers. These consist of fuses and accessories for industrial, commercial, automotive, residential, electronic, agricultural, marine, and aerospace applications. As the leader in circuit protection technology no other company offers a product line as complete as Bussman's.

## AGC GLASS FUSES



KJ-5



AGC

INDIVIDUAL FUSES PRICED EACH  
PACKAGED 5 FUSES PER TIN BOX

FUSE ASSORTMENTS ARE INDIVIDUAL CARDED,  
PRICED AND SOLD EACH

**PART NO.**

374-2983

**DESCRIPTION**

KJ-5 GLASS FUSE ASSORTMENT  
FOR JAPANESE CARS, CONTAINS:  
GLASS AGC-5, 10, 15, 20 & 30

374-2901

374-2902

374-2903

374-2904

374-2905

374-2906

374-2907

374-2908

374-2909

374-2910

374-2911

374-2912

374-2913

374-2914

374-2915

AGC-1 GLASS FUSE

AGC-10 GLASS FUSE

AGC-1 1/2 GLASS FUSE

AGC-15 GLASS FUSE

AGC-2 GLASS FUSE

AGC-20 GLASS FUSE

AGC-25 GLASS FUSE

AGC-3 GLASS FUSE

AGC-30 GLASS FUSE

AGC-40 GLASS FUSE

AGC-5 GLASS FUSE

AGC-50 GLASS FUSE

AGC-6 GLASS FUSE

AGC-7 GLASS FUSE

AGC-7 1/2 GLASS FUSE

## SFE GLASS FUSES



UK-6

INDIVIDUAL FUSES PRICED EACH  
PACKAGED 5 FUSES PER TIN BOX

FUSE ASSORTMENTS ARE INDIVIDUAL CARD-  
ED, PRICED AND SOLD EACH



SFE

**PART NO.**

374-2982

**DESCRIPTION**

UK-6 GLASS FUSE ASSORTMENT  
FOR AMERICAN CARS, CONTAINS:  
GLASS AGC-5, 15, 30, SFE-9, 14, & 20

374-2970

374-2971

374-2972

374-2973

374-2974

374-2975

SFE-14 GLASS FUSE

SFE-20 GLASS FUSE

SFE-30 CLASS FUSE

SFE-6 CLASS FUSE

SFE-7 1/2 GLASS FUSE

SFE-9 GLASS FUSE

## ATC BLADE FUSES

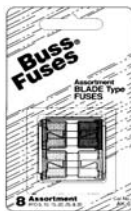

AK-6

INDIVIDUAL FUSES PRICED EACH  
PACKAGED 5 FUSES PER TIN BOX

FUSE ASSORTMENTS ARE INDIVIDUAL CARD-  
ED, PRICED AND SOLD EACH

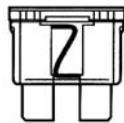

ATC®

**PART NO.**

374-2920

**DESCRIPTION**

AK-6 BLADE FUSE ASSORTMENT  
CONTAINS: BLADE TYPE ATC-5, 10,  
15, 20, 25, & 30

374-2930

374-2931

374-2932

374-2933

374-2934

374-2935

374-2936

374-2937

374-2938

ATC-10 BLADE FUSE

ATC-15 BLADE FUSE

ATC-20 BLADE FUSE

ATC-25 BLADE FUSE

ATC-3 BLADE FUSE

ATC-30 BLADE FUSE

ATC-4 BLADE FUSE

ATC-5 BLADE FUSE

ATC-7 1/2 BLADE FUSE

Modern Ag Parts - Beaumont, Texas - Order Toll-Free 1-888-404-8908 - Fax Toll-Free 1-888-404-8910

# Buss® Fuses

## ATM BLADE FUSES



MINI® ATM

KM-8

INDIVIDUAL FUSES PRICED EACH  
PACKAGED 5 FUSES PER TIN BOX

FUSE ASSORTMENTS ARE INDIVIDUAL CARD-  
ED, PRICED AND SOLD EACH

**PART NO.**

374-2984

374-2940

374-2941

374-2942

374-2943

374-2944

374-2945

374-2946

374-2947

374-2948

374-2949

**DESCRIPTION**

KM-8 BLADE FUSE ASSORTMENT  
CONTAINS: BLADE TYPE ATM-2, 5,  
7 1/2, 10, 15, 20, 25, & 30

ATM-10 BLADE FUSE

ATM-15 BLADE FUSE

ATM-2 BLADE FUSE

ATM-20 BLADE FUSE

ATM-25 BLADE FUSE

ATM-3 BLADE FUSE

ATM-30 BLADE FUSE

ATM-4 BLADE FUSE

ATM-5 BLADE FUSE

ATM-7 1/2 BLADE FUSE

## MAX BLADE FUSES



MAXI® MAX  
1 FUSE PER BOX

**PART NO.**

374-2960

374-2961

374-2962

374-2963

374-2964

**DESCRIPTION**

MAX-20 BLADE FUSE

MAX-30 BLADE FUSE

MAX-40 BLADE FUSE

MAX-50 BLADE FUSE

MAX-60 BLADE FUSE

## FUSE HOLDERS

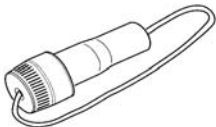

**PART NO.**

374-2898

374-2899

374-2900

**DESCRIPTION**

FUSEHOLDER W/SFE-9 FUSE & 19" OF 14GA LEAD

FUSEHOLDER W/SFE-14 FUSE & 19" OF 14GA LEAD

FUSEHOLDER W/SFE-20 FUSE & 8" OF 14GA LEAD

## FUSE KIT



AT-7

**PART NO.**

374-2981

**DESCRIPTION**

AT-7 FUSE KIT W/BLADE TYPE FUSE PULLER

CONATINS: ATC-5, 10, 15, 20, 25, & 30

## FUSE DISPLAY

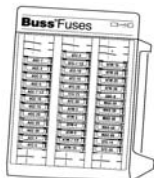

NO.200

**PART NO.**

374-2980

**DESCRIPTION**

FUSE DISPLAY (FUSES SOLD SEPARATELY)

HOLDS 40 TINS OF ASSORTED FUSES .

THIS STURDY, SERVICEABLE DISPLAY MAKES IT  
EASY TO MERCHANDISE A VARIETY OF FUSES.

3 PT. & TRACTOR ACCESSORIES

Wire Terminals  
Wire Terminal Kits

Modern Ag Parts - Beaumont, Texas - Order Toll-Free 1-888-404-8908 - Fax Toll-Free 1-888-404-8910

## WIRE TERMINALS

### ALL ITEMS SOLD IN BAG QUANTITIES

#### RING TERMINALS

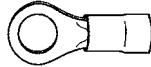

PVC Crimp Ring Terminals

Part No.	Wire Size/Color	Stud Size	Bag Qty.
374-13104	18-22 ga/red	#10 (5.3mm)	21
374-13105	14-16 ga/blue	1/4" (6.4mm)	17
374-13106	14-16 ga/blue	#8 (4.3mm)	22
374-13107	14-16 ga/blue	#10 (5.3mm)	21
374-13108	10-12 ga/Yellow	1/4" (6.4mm)	14
374-13110	10-12 ga/Yellow	3/8" (10.5mm)	13

#### DISCONNECT TERMINALS

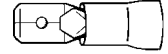

PVC Crimp Disconnect Terminals. 1/4" tab (6.4 mm)

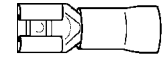

Part No.	Wire Size/Color	Type	Bag Qty.
374-13115	18-22 ga - red	Female	21
374-13116	14-16 ga - blue	Female	20
374-13117	10-12 ga - Yellow	Female	16
374-13118	18-22 ga - red	Male	18
374-13119	14-16 ga - blue	Male	18
374-13120	10-12 ga - Yellow	Male	16

#### SPADE TERMINALS

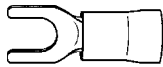

PVC Crimp Spade Terminals

Part No.	Wire Size/Color	Stud Size	Bag Qty.
374-13111	18-22 ga - red	#8 (4.3mm)	20
374-13112	14-16 ga - blue	#8 (4.3mm)	20
374-13113	14-16 ga - blue	#10 (5.3mm)	20

#### T-TAP CONNECTOR SET

T-Tap PVC Connector Set

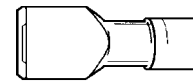

Part No.	Wire Size	Bag Qty.
374-13132	16-14 ga	3

#### BUTT CONNECTORS

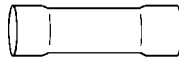

PVC Crimp Butt Connectors

Part No.	Wire Size/Color	Bag Qty.
374-13101	18-22 ga - red	22
374-13102	14-16 ga - blue	21
374-13103	10-12 ga - Yellow	15

#### Closed End Joints

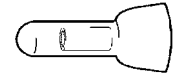

PVC Crimp Closed End Joints

Part No.	Wire Size	Bag Qty.
374-13134	14-16 ga	12
374-13135	10-12 ga	9

#### BULLET TERMINALS

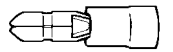

PVC Crimp Bullet Terminals

Stud Size .157" Dia (4mm)



Part No.	Wire Size/Color	Bag Qty.
374-13121	14-16 ga - blue F	7
374-13122	14-16 ga - blue M	20

## WIRE TERMINAL KITS



- 1089 pcs.**      **Part No. 374-3100**
- Pre-packed assortment of wire terminal.
  - Container has a rust & acid resistant baked enamel finish.
  - Will fit in our 847-2099 cabinets.

#### QUICK SPLICE CONNECTORS

PVC Quick Splices

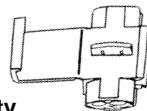

Part No.	Wire Size/Color	Bag Qty.
374-13125	14-18 ga - blue	5

**Sold in bag qty.**

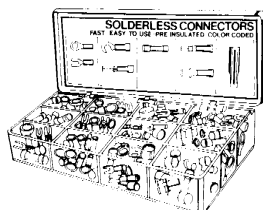

An excellent introduction assortment ideally suited for expeditors, jobbers & maintenance specialists. 18 different types of the most popular used pre-insulated terminals, 175 total pieces - balanced to popularity. Packaged in a plastic storage box with I.D. chart & cardboard sleeve.

**Part No.**  
374-1

CONTAINS	PIECES	CONTAINS	PIECES
374-13101	60	374-13115	50
374-13102	60	374-13116	40
374-13103	40	374-13117	40
374-13104	60	374-13118	30
374-13105	50	374-13119	50
374-13106	60	374-13120	40
374-13107	60	374-13121	40
374-13108	30	374-13122	50
374-13110	30	374-13125	20
374-1311160		374-13132	9
374-13112	60	374-13134	60
374-13113	60	374-13135	40

Modern Ag Parts - Beaumont, Texas - Order Toll-Free 1-888-404-8908 - Fax Toll-Free 1-888-404-8910



**NEW! From Performance Tools  
 5 and 10 Gallon Air Tanks**

- 125 PSI Maximum Pressure
- Light-weight, portable with handle for easy transport
- Safety pressure bypass valve with manual override
- On-Off air adjustment dial
- Industrial grade air hose with standard tire air chuck
- Hi-viz color for added visibility
- Packaged in color display box

MAP NO.	MFG.NO.	DESCRIPTION
800-109	W10005	5 Gallon Air Tank
800-110	W10011	10 Gallon Air Tank
800-105	W10057	4' Replacement Hose
800-111	W10056	Brass Tank Manifold
800-112	W10055	Air Tank Gauge



- NEW!**  
**AIR HOSE REELS**  
 25' 300 PSI AIR HOSE ON REEL
- Industrial grade reel includes 3/8" NPT x 25' Hose
  - Maximum 300 PSI working pressure
  - Spring powered auto rewind makes hose return a snap

**MAP NO.** 308-1426  
**MFG.NO.** M608



- NEW!**  
**50' 300 PSI AIR HOSE ON REEL**
- 50' 300 PSI 3/8" Air Hose
  - All brass 1/4" NPT 360 swivel valve
  - Includes 3' lead supply hose with swivel valve
  - Easy crank handle with spring tension brake
  - Reel can hold up to 100' of 3/8" hose

**MAP NO.** 308-1427  
**MFG.NO.** M610



Modern Ag Parts - Beaumont, Texas - Order Toll-Free 1-888-404-8908 - Fax Toll-Free 1-888-404-8910



## BLOW GUNS

### MILTON SAFETY BUTTON BLO-GUN STREAMLINED SHAPE COMFORTABLY FITS THE HAND

INDISPENSABLE FOR CLEANING FUEL AND OIL LINES, AIR CLEANERS AND CAR INTERIORS, DRYING OUT WET IGNITION SYSTEMS AND SPARK PLUGS, BLOWING OUT DUST, DIRT FILINGS, METAL CHIPS AND HUNDREDS OF OTHER USES. A NECESSITY FOR SERVICE STATIONS, GARAGES, AIRPORTS, FACTORIES OR WHEREVER AN AIR HOSE IS USED.

MILTON NO.	PART NO.	DESCRIPTION
107	811-107	BUTTON BLO-GUN 1/4" N.P.T.

MEETS "OSHA" REQUIREMENTS OF SPECIAL RELIEF HOLES IN NOZZLE WHICH LIMITS PRESSURE TO 30 P.S.I. WHEN DEAD ENDED (STATIC PRESSURE).



### MILTON ADJUSTABLE POCKET BLO-GUN

**E-Z-GRIP** TWO FINGER AIR CONTROL ADJUSTS FROM A MERE WHISPER TO FULL VOLUME AIR FLOW. SPECIALLY DESIGNED KNURLED TIP ALLOWS SECURE HANDLING, EVEN WITH OILY OR GREASY HANDS. MAXIMUM INLET PRESSURE 150 PSI. FOR ALL MILTON M STYLE OR ANY 1/4" BASIC SIZE INDUSTRIAL COUPLER BODY.

MILTON NO.	PART NO.	DESCRIPTION
115	811-115	ADJUSTABLE POCKET BLO-GUN



### MILTON BLO-GUN WITH 4' OR 2' EXTENSION BLO-GUN WITH 4' OR 2' ALUMINUM EXTENSION, INCLUDES 2 NOZZLES. SAFETY AND NON-SAFETY RUBBER TIP.

MILTON NO.	PART NO.	DESCRIPTION
159	811-159	BLOWGUN W/4' EXTENSION 1/4" N.P.T.
158	811-158	BLOWGUN W/2' EXTENSION 1/4" N.P.T.



### FULL FLOW MILTON SAFETY LEVER BLO-GUN LEVER EASILY CONTROLS AIR FLOW

A PRECISION INSTRUMENT WITH HUNDREDS OF AUTOMOTIVE AND INDUSTRIAL USES- RUGGED CONSTRUCTION FOR EXTRA SERVICE-USED IN SMALL OR LARGE INDUSTRIAL PLANTS, AIRPORTS, SERVICE STATIONS OR GARAGES.

MILTON NO.	PART NO.	DESCRIPTION
150	811-150	LEVER BLO-GUN 1/4" N.P.T.

MEETS OSHA REQUIREMENTS OF SPECIAL RELIEF HOLES IN NOZZLE WHICH LIMITS PRESSURE TO 30 P.S.I. WHEN DEAD ENDED (STATIC PRESSURE).

### RUBBER TIP BLO-GUNS

#### LEVER BLO-GUN, 1/4" NPT AIR INLET, WITH RUBBER TIP.

FOR POSITIVE LEAK-PROOF CONNECTION WHEN BLOWING OUT ANY FLUID LINES. A MUST WHERE METAL TIP COULD MAR DELICATE FINISH IN MOLDS OR FRESH PAINT.



MILTON NO.	PART NO.	DESCRIPTION
s153	811-153	RUBBER TIP BLO-GUN 1/4" N.P.T.
152	811-113	RUBBER TIP, PRICED & SOLD 10 PER PACKAGE



### MILTON SIPHON SPRAY BLO-GUN

DEGREASE ENGINES AND PARTS, SPRAY LIVESTOCK, PLANTS AND FLOWERS, CLEAN WALLS, GREASE BAY AND DRIVEWAYS, RUSTPROOF TOOLS AND MACHINERY

MILTON NO.	PART NO.	DESCRIPTION
157	811-157	SIPHON SPRAY BLO-GUN KIT 1/4" N.P.T.*

\*COMPLETE WITH 8' OF TUBING AND VINYL STORAGE POUCH

Modern Ag Parts - Beaumont, Texas - Order Toll-Free 1-888-404-8908 - Fax Toll-Free 1-888-404-8910

## TIRE VALVE & CORE STEMS

**MILTON VALVE CORES**  
 POSITIVE SEAL FAST INFLATION  
 GUARANTEED AIRTIGHT



MILTON NO.	PART NO.	DESCRIPTION
404	811-404	VALVE CORE, 5 PER CARD 10 CARDS PER BOX

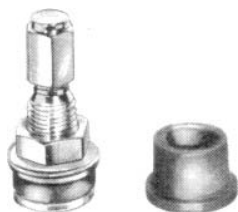

**MILTON HI-PERFORMANCE TIRE VALVE**  
 THAT CUSTOM LOOK FOR MAG WHEELS, ALUMINUM WHEELS, EXPOSED WHEELS, AND REVERSE CHROME WHEELS. TIRE VALVE COMES WITH TWO GROMMETS, FOR LARGE OR SMALL RIM HOLE SIZE.

MILTON NO.	PART NO.	DESCRIPTION
409	811-409	TIRE VALVE AND GROMMET, 1 PER CARD, 10 CARDS PER BOX



**MILTON TUBELESS TIRE VALVES**  
 "SNAP-IN" TYPE CONSTRUCTION FOR EASY INSTALLATION.  
 FINEST QUALITY  
 GREATER SAFETY  
 OZONE RESISTANT RUBBER

PART NO.	TR NO.	RIM HOLE DIA.	EFFECTIVE LENGTH
811-413	TR 413	.453"	1-1/4"
811-415	TR415	5/8"	1-1/4"
811-418	TR418	.453	2"
811-425	TR425	5/8"	2"



415

413

SKIN PAK 2 PER INDIVIDUAL CARD PRICED PER CARD

418

425



### MILTON VALVE CAPS



437

MILTON NO.	PART NO.	DESCRIPTION
437	811-437	VALVE CAP, SCREW DRIVER TYPE, BRASS; NICKLE PLATED, 10 CARDS PER BOX PRICED PER CARD OF 5
439	811-439	VALVE CAP, DOME TYPE, PLASTIC, 10 CARDS PER BOX PRICED PER CARD OF 5

439

## MILTON HANDY BEND WATER NOZZLE

BEND HOSE...WATER FLOWS, RELEASE...WATER STOPS



NO WASTE WATER...MANY USES AROUND THE SERVICE STATION, GARAGE, HOME, FARM, CANNERY, PACKING HOUSE, FACTORY, ETC.

MILTON NO.	PART NO.	DESCRIPTION
300	811-300	HANDEE-BEND WATER NOZZLE (APPROX. 4" LONG) FEMALE GARDEN HOSE THREAD

Modern Ag Parts - Beaumont, Texas - Order Toll-Free 1-888-404-8908 - Fax Toll-Free 1-888-404-8910

## VALVE ACCESSORIES



442

### MILTON BRASS VALVE EXTENSIONS

"VALVE PIN" TYPE DESIGN ALLOWS COMPLETE SERVICING!

CHECK PRESSURE INFLATE DEFLATE

THREADED FOR VALVE CAPS....AND/OR USE WITH LOCKS FOR EXPENSIVE WHEEL COVERS

MILTON NO.	PART NO.	DESCRIPTION
442	811-442	VALVE EXTENSION 1-1/4" EFFECTIVE LENGTH 4 PER CARD 10 CARD PER BOX



445

### MILTON VALVE REPAIR TOOL

THE 4 IN 1 TOOL FOR VALVE STEM AND CORE!

LOOK...RETHREADS INSIDE AND OUTSIDE OF VALVE STEM...INSERT, TIGHTEN OR REMOVE VALVE CORE (WITH GUIDE WHICH SLIPS OVER STEM)... "EASY-OUT" TO REMOVE CORE IF SHOULDERS ARE BROKEN OFF..ALL STEEL, PLATED TO RESIST CORROSION.

MILTON NO.	PART NO.	DESCRIPTION
445	811-445	VALVE REPAIR TOOL 4 IN 1



446

### MILTON TUBE DEFLATOR & CORE REMOVER

THE 2 IN 1 TOOL...DEFLATOR ON ONE END; THREADED I.D. ENABLES ATTACHMENT TO VALVE STEM...VALVE CORE WRENCH ON THE OTHER END, TO INSERT AND TIGHTEN OR REMOVE CORE.

MILTON NO.	PART NO.	DESCRIPTION
446	811-446	TUBE DEFLATOR & CORE STEM REMOVER

### MILTON PLASTIC EXTENSIONS

LIGHTWEIGHT...DOES NOT AFFECT WHEEL BALANCE

FOR USE WITH DECORATIVE WHEEL COVERS. EXTENDS VALVE THROUGH HOLE COVER. FOR EASE IN INFLATING OR CHECKING PRESSURE.



453

452

MILTON NO.	PART NO.	DESCRIPTION
452	811-452	VALVE EXTENSION 1-1/4" EFFECTIVE LENGTH 4 PER CARD 10 CARDS PER BOX
453	811-453	VALVE EXTENSION 1-1/2" EFFECTIVE LENGTH 4 PER CARD 10 CARDS PER BOX

MILTON NO.	PART NO.	DESCRIPTION
462	811-462	TR128A TRACTOR VALVE NEW DESIGN FAST-FLOW. FOR ROAD GRADER AND TRACTOR TUBES. BASE PREPARED FOR ELECTRIC OR CHEMICAL APPLICATION TO TUBE BASE 3-1/4" LENGTH 1-27/32" (INDIVIDUALLY CARDED FOR DISPLAY 5 CARDS PER BOX
463	811-463	TR LN-10 RIM NUT FITS NEW AND OLD STYLE AIR/WATER TRACTOR VALVES (10 PER ENVELOPE)
464	811-464	TR CH-3 REPLACEMENT CORE HOUSING COMPLETE WITH VALVE CORE AND CAP FITS FAST FLOW TRACTOR VALVES (S462-TR-218A) PACKED 2 PER CARD 10 CARDS PER BOX
465	811-465	TR CH-1 REPLACEMENT CORE HOUSING COMPLETE WITH VALVE CORE AND CAP FITS OLD STYLE AIR/WATER TRACTOR VALVES. PACKED 2 PER CARD 10 CARDS PER BOX



s462



s465



s464

463



Modern Ag Parts - Beaumont, Texas - Order Toll-Free 1-888-404-8908 - Fax Toll-Free 1-888-404-8910

## VALVE ACCESSORIES

### MILTON AIR/WATER ADAPTER KIT



s466

**s466 AIR/WATER ADAPTER KIT.** FAST FLOW, COMPLETE WITH 2 EXTRA bushing 467 AND 468 TO FIT ALL AIR/WATER VALVES IN USE TODAY. CONNECT GARDEN HOSE TO TIRE VALVES FOR FILLING TIRES WITH LIQUID. PACKED ONE KIT PER CARD. 5 CARDS PER BOX.

**PART NO. 811-466**

### MILTON TUBELESS AIR-LIQUID VALVE



469

CLAMP-IN TUBELESS VALVE FOR FARM TRACTOR AND ROAD GRADER TIRES...FAST FILLING, LARGE BORE TYPE...COMPLETE WITH MILTON NO. s464 CORE HOUSING.

MILTON NO.	PART NO.	DESCRIPTION
469	811-469	AIR LIQUID TUBELESS VALVE 5 PER BOX



470

### CLAMP-IN TUBELESS TIRE VALVES

RECOMMENDED WHERE TIRE PRESSURES EXCEED 45 P.S.I.  
**470 (TR416) UNIVERSAL...**RUBBER GROMMETS FIT. 453" OR 5/8" RIM HOLES. 5 PER BOX.

**PART NO.**

811-470



406

### TUBE TYPE TIRE VALVES

FOR PASSENGER CARS, MOTORCYLES, LIGHT TRUCKS AND INDUSTRIAL VEHICLES. 2-1/4" BASE. APPLY HOT OR COLD



473

MILTON NO.	PART NO.	DESCRIPTION
406	811-406	RIM HOLE BUSHING FOR TUBE VALVES REDUCES .625" (5/8") HOLE DIA. TO .453" SIZE 100 PER BOX
473	811-473	PATCH VALVE 1 3/8" LONG. FOR .453" RIM HOLE. FITS 13", 14" AND 15" TUBES. 5 PER BOX

## AIR HOSE FITTINGS

### MILTON BRASS HOSE ENDS



600  
602  
603

MILTON NO.	PART NO.	DESCRIPTION
600	811-600	MALE HOSE END 1/4" I.D. HOSE X 1/4" N.P.T.
602	811-602	MALE HOSE END 3/8" I.D. HOSE X 1/4" N.P.T.
603	811-603	MALE HOSE END 3/8" I.D. X 3/8" N.P.T.

SKIN PAK 2 PER INDIVIDUAL CARD PRICED PER CARD

### MILTON BRASS HOSE MENDERS

640  
642-1  
642



MILTON NO.	PART NO.	DESCRIPTION
*640	811-640	1/4" I.D. HOSE BOTH ENDS
*642	811-642	3/8" I.D. HOSE BOTH ENDS
642-1	811-6421	1/2" I.D. HOSE BOTH ENDS

\*SKIN PAK 2 PER INDIVIDUAL CARD PRICED PER CARD

Modern Ag Parts - Beaumont, Texas - Order Toll-Free 1-888-404-8908 - Fax Toll-Free 1-888-404-8910

## AIR HOSE FITTINGS

### MILTON TANK CONVERSION KIT

s 682



MAKE YOUR EMPTY FREON TANKS INTO USABLE OR SALABLE AIR TANKS. DO IT YOURSELF. NO SPECIAL TOOLS REQUIRED.

**COMPLETE PARTS KIT CONTAINS:** FILLER VALVE, AIR GAUGE, SAFETY VALVE ASSEMBLY, AIR HOSE ASSEMBLY, CHUCK AND 4-WAY MANIFOLD.

MILTON NO.	PART NO.	DESCRIPTION
682	811-682	TANK CONVERSION KIT

### TANK VALVES AND SAFETY VALVES

684



MILTON NO.	PART NO.	DESCRIPTION
684	811-684	TANK VALVE 1/8" N.P.T. MALE

SKIN PAK 2 PER INDIVIDUAL CARD PRICED PER CARD

### MILTON AIR CHUCKS

PRECISION CONSTRUCTION



DESIGNED AND MANUFACTURED TO EXACTING STANDARDS.

MILTON NO.	PART NO.	DESCRIPTION
690	811-690	DUAL HEAD CHUCK 1/4" FEMALE N.P.T.

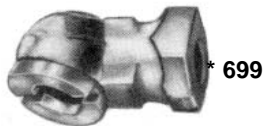

MILTON NO.	PART NO.	DESCRIPTION
699	811-699	FEMALE AIR CHUCK 1/4" N.P.T.

### MILTON SAFETY GRIP AIR CHUCKS

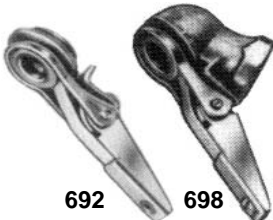

MILTON NO.	PART NO.	DESCRIPTION
692	811-692	SAFETY GRIP CHUCK CLIP ONLY (FITS ALL STANDARD SINGLE HEAD CHUCKS)
698	811-698	CHUCK CLIP WITH FEMALE AIR CHUCK 1/4" N.P.T.

### P STYLE

3/8" BASIC SIZE

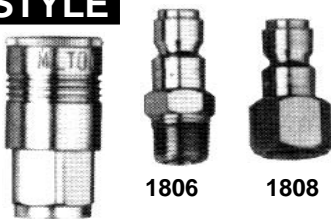

1806

1808

1805

1/4" BASIC SIZE

### A-M-T STYLE



1806

1808

### MILTON "KWIK-CHANGE" "P" STYLE COUPLER

3/8" BASIC SIZE TRU-FLATE/PARKER STYLE INTERCHANGE SERIES. COUPLER BODIES ARE HEAVY DUTY CASE HARDENED STEEL AND TREATED TO RESIST RUST

MILTON NO.	PART NO.	DESCRIPTION
1805	811-1805	3/8" N.P.T. FEMALE BODY
*1807	811-1807	3/8" N.P.T. MALE PLUG
*1808	811-1808	3/8" N.P.T. FEMALE PLUG

\*SKIN PAK 2 PER INDIVIDUAL CARD PRICED PER CARD

### 1/4" BASIC SIZE - 3 WAY COUPLERS

ACCEPTS THE THREE MOST POPULAR 1/4" BASIC STYLE PLUGS SOLD IN U.S. RUST RESISTANT--MADE OF HEAVY DUTY BRASS. PUSH TYPE--BODY ENGAGES AUTOMATICALLY. DRAG GUARD VIRTUALLY ELIMINATES ACCIDENTAL DISCONNECTION, IDEAL WHEN CUSTOMERS ARE UNSURE WHAT COUPLER OR PLUG THEY NEED.

MILTON NO.	PART NO.	DESCRIPTION
745	811-745	1/4" N.P.T. FEMALE BODY
746	811-746	1/4" N.P.T. MALE BODY

Modern Ag Parts - Beaumont, Texas - Order Toll-Free 1-888-404-8908 - Fax Toll-Free 1-888-404-8910

1/4" BASIC SIZE

## AIR HOSE FITTINGS

### MILTON "KWIK-CHANGE" "M" COUPLERS

USED WITH ALL AIR OPERATED EQUIPMENT SUCH AS: BLOW GUNS, TIRE INFLATORS, PAINT SPRAYERS, AIR HAMMERS, AIR DRILLS, GREASING EQUIPMENT, OIL SPRAYS, RETREADING AND VULCANIZING EQUIPMENT.

711



727

**M  
STYLE**

MILTON NO.	PART NO.	DESCRIPTION
711	811-711	KWIK CHANGE COUPLER ASSEMBLY (NO 715 BODY AND 727 PLUG 1/4" N.P.T. FEMALE AND 1/4" N.P.T. MALE)



715



716

MILTON NO.	PART NO.	DESCRIPTION
715	811-715	1/4" N.P.T. FEMALE COUPLER BODY

MILTON NO.	PART NO.	DESCRIPTION
716	811-716	1/4" N.P.T. MALE COUPLER BODY

MILTON NO.	PART NO.	DESCRIPTION
727	811-727	1/4" N.P.T. MALE COUPLER PLUG

SKIN PAK 2 PER INDIVIDUAL CARD PRICED PER CARD



728

MILTON NO.	PART NO.	DESCRIPTION
728	811-728	1/4" N.P.T. FEMALE COUPLER PLUG

SKIN PAK 2 PER INDIVIDUAL CARD PRICED PER CARD

**A  
STYLE**

1/4" BASIC SIZE

### MILTON "KWIK-CHANGE" "A" COUPLERS

DESIGNED TO INTERCHANGE WITH ARO STYLE COUPLERS 1/4" BASIC SIZE\*PUSH TYPE-PLUG ENGAGES AUTOMATICALLY\*STEEL BODY-WITH HARDENED STEEL PLUGS. RUGGED, DURABLE.



775



777

MILTON NO.	PART NO.	DESCRIPTION
775	811-775	1/4" N.P.T. FEMALE "A" COUPLER PLUG

MILTON NO.	PART NO.	DESCRIPTION
777	811-777	1/4" N.P.T. MALE "A" COUPLER PLUG

SKIN PAK 2 PER INDIVIDUAL CARD PRICED PER CARD

### MILTON "KWIK-CHANGE" "T" COUPLERS

DESIGNED TO INTERCHANGE WITH TRU-FLARE, PARKER HANNIFIN STYLE COUPLERS.

1/4" BASIC SIZE HARDENED STEEL PLUGS, RUST RESISTANT, MAXIMUM AIR FLOW FOR 1/4" COUPLERS.

**T  
STYLE**

1/4" BASIC SIZE



783



785

MILTON NO.	PART NO.	DESCRIPTION
783	811-783	1/4" N.P.T. MALE "T" COUPLER PLUG

SKIN PAK 2 PER INDIVIDUAL CARD PRICED PER CARD

MILTON NO.	PART NO.	DESCRIPTION
785	811-785	1/4" N.P.T. FEMALE "T" COUPLER PLUG

### MILTON "KWIK-CHANGE" LINCOLN STYLE COUPLER

1/4" BASIC SIZE PUSH TYPE-PLUG ENGAGES AUTOMATICALLY, STEEL BODY - WITH HARDENED STEEL PLUGS, RUGGED, DURABLE.



790



791

**L  
STYLE**

MILTON NO.	PART NO.	DESCRIPTION
790	811-790	1/4" N.P.T. FEMALE BODY
*791	811-791	1/4" N.P.T. MALE PLUG

\*SKIN PAK 2 PER INDIVIDUAL CARD PRICED PER CARD

Modern Ag Parts - Beaumont, Texas - Order Toll-Free 1-888-404-8908 - Fax Toll-Free 1-888-404-8910

## TIRE GAUGES

### DIAL-TYPE GAUGE



**MILTON 902**

**PART NO.**  
811-902

### LO-PRESSURE-MID RANGE-HI-PRESSURE

DESIGNED TO STAY ACCURATE-RUGGED BRONZE BOURDON TUBE-PRECISION MADE, FULL GEARED BRASS MOVEMENT. LARGE-EASY TO READ DIAL. UNBREAKABLE CRYSTAL. TESTED BEFORE SHIPMENT-EVERY GAUGE IS TESTED AND CHECKED ON MASTER GAUGE PRIOR TO PACKAGING-GUARANTEERING ACCURACY OF THE HIGHEST STANDARDS. PRESSURE IS INDICATED ON DIAL UNTIL RELEASE VALVE IS DEPRESSED. 0-60 P.S.I.-IN 1 LB.INCREMENTS. ALL WITH COMPOSITE kPA/P.S.I. SCALE.

### MILTON PENCIL TYPE GAUGES

MILTON PENCIL TYPE GAUGES PROVIDE THE FINEST IN ACCURATE, LONG LIFE, TROUBLE FREE PERFORMANCE. DESIGNED AND CONSTRUCTED TO PROVIDE THE QUALITY THAT MEANS SATISFACTION IN USE AND A LEVEL OF EXCELLENCE UNSURPASSED BY ANY OTHER MANUFACTURER.

### NYLON INDICATOR BAR WITH RED MARKER

**MILTON 921**

**PART NO.**  
811-921



MILTON RADIAL AND CONVENTIONAL PASSENGER TIRE GAUGE, 2 SIDES 5 TO 50 P.S.I. IN 1 LB. INCREMENTS AND 2 SIDES KILO PASCALS(kPA) 40 TO 350 IN 10 kPA INCREMENTS.

**MILTON 925**

**PART NO.**  
811-925



TIRE GAUGES FOR BICYCLES, RV'S & TRUCKS, 2 SIDES 20 TO 120 P.S.I. IN 2 LB. INCREMENTS AND 2 SIDES KILO PASCALS (kPA) 120 TO 820 IN 20 kPA INCREMENTS.

**MILTON 927**

**PART NO.**  
811-927



DUAL CHUCK TRUCK TIRE GAUGE, 2 SIDES 20 TO 120 P.S.I. IN 2 LB. INCREMENTS AND 2 SIDES KILO PASCALS (kPA) 120 TO 820 IN 20 kPA INCREMENTS.

**MILTON 928**

**PART NO.**  
811-928

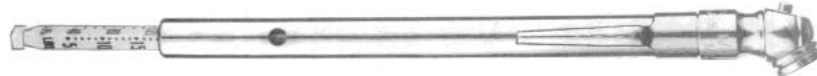

TRACTOR TIRE GAUGE (FOR USE ON AIR/WATER FILLED TIRES) CALIBRATED 2 SIDES FROM 5 TO 50 LBS. IN 1 LB.UNITS AND 2 SIDES KILO PASCALS (kPA) 40 TO 350 IN 10 kPA INCREMENTS.

### MILTON SERVICE GAUGES(10 TO 160 LBS.)

PRECISION ENGINEERED TO GIVE YOU MASTER GAUGE ACCURACY IN A LONG LIFE SERVICE GAUGE. YOUR CHOICE...STANDARD DUAL-HEAD CHUCK IN SHORT EXTENSION. ALSO, "JUMBO" DUAL-HEAD CHUCK WITH REGULAR EXTENSION... ALL MODELS WITH THE SAME LONGER AND STRONGER BODY...

### EASY TO READ NYLON INDICATOR BAR

CALIBRATED TWO SIDES FROM 10 TO 160 LBS. IN 2 LB. UNITS AND TWO SIDES FROM 80 TO 1100 KILO PASCALS IN 20 kPA UNITS...RED MARKER

**MILTON 976**

**PART NO.**  
811-976



REGULAR EXTENSION SERVICE GAUGE (DUAL HEAD CHUCK)

**3 PT. & TRACTOR ACCESSORIES**

Battery-Starter Tester

Slow-Moving Vehicle Emblems SMV Emblem Display Rack

Modern Ag Parts - Beaumont, Texas - Order Toll-Free 1-888-404-8908 - Fax Toll-Free 1-888-404-8910

## BATTERY-STARTER TESTER

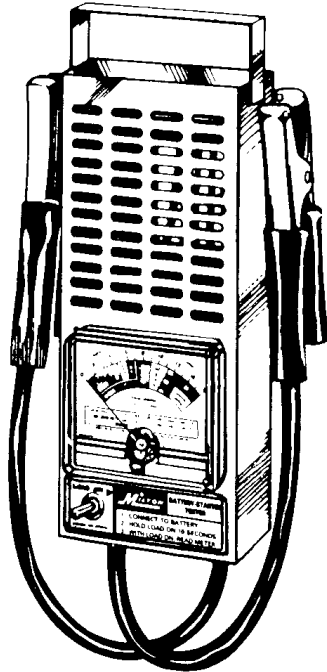

### BATTERY TESTING-

LOAD TESTS 6 AND 12 VOLT AUTO AND TRUCK BATTERIES

CONVENTIONAL & MAINTENANCE-FREE

BUILT-IN LIMITS FOR LARGE AND SMALL BATTERIES.

### STARTER TESTING-

FAST, EASY TEST FOR EXCESSIVE STARTER CURRENT DRAW.

HELPS EVALUATE HARD STARTING COMPLAINTS.

### CHARGING SYSTEM CHECK-

SIMPLE, OVER-ALL CHECK OF CHARGING SYSTEM.

MINIMIZES BATTERY COME-BACKS DUE TO CHARGING SYSTEM TROUBLE.

**PART NO.**

**811-1260**

1260-6 BATTERY TESTER

**1 YEAR WARRANTY**

**REPLACEMENT LOAD SWITCH**

PART NO.	MFG. NO.
----------	----------

811-1262	P10-2-1N
----------	----------

### FAST 20 SECOND TEST

1. CONNECT TO BATTERY.
2. HOLD LOAD SWITCH ON FOR 10 SECONDS.
3. READ BATTERY CONDITION ON METER DIAL.

## SLOW - MOVING VEHICLE EMBLEMS

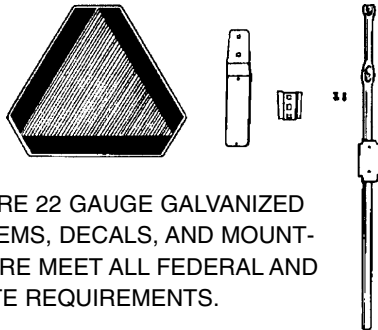

EMBLEMS ARE 22 GAUGE GALVANIZED STEEL EMBLEMS, DECALS, AND MOUNTING HARDWARE MEET ALL FEDERAL AND STATE REQUIREMENTS.

## SMV EMBLEM DISPLAY RACK

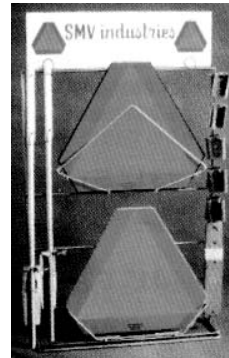

SMV EMBLEM DISPLAY RACK IS EASILY ASSEMBLED (24" X 8" X 32" HIGH) AND TAKES ONLY 3 SQ. FEET OF SPACE. MADE FROM LIGHT WEIGHT, STURDY 3/8" ALUMINUM ROD. THIS DISPLAY IS SOLD ALONE. SMV EMBLEMS ARE SOLD SEPARATELY.

PART NO.	DESCRIPTION
750-1	SMV STEEL BACKED EMBLEM
750-4	SMV FILM DECAL EMBLEM
750-2	SMV MOUNTING BLADE
750-3	SMV MOUNTING SOCKET
750-5	POLE ASSEMBLY
750-6	SMV PLASTIC BACKED EMBLEM

### RACK WILL HOLD:

- 10) 750-1 STEEL BACKED EMBLEM
- 6) 750-2 MOUNTING BRACKET
- 12) 750-3 SMV MOUNTING SOCKET
- 6) 750-4 FANNY FLAG SMV EMBLEM DECAL
- 4) 750-5 POLE ASSEMBLY

PLASTIC, STEEL AND DECAL EMBLEMS ARE PACKED AND SOLD 12 PER CARTON

**PART NO.**

750-11

**MFG NO.**

Model #10-CDR

Modern Ag Parts - Beaumont, Texas - Order Toll-Free 1-888-404-8908 - Fax Toll-Free 1-888-404-8910

## HARDWOOD KNOB STEERING WHEEL SPINNERS

CONSTRUCTED OF A HEAVY STEEL BASE PLATE, RED  
HARDWOOD KNOB AND OTHER MATERIALS. ALL  
COMPLETELY WEATHER AND RUST PROOFED,  
ASSURING LONG AND SATISFACTORY SERVICE.  
COMES WITH 12 KNOBS IN ATTRACTIVE COUNTER  
DISPLAY.



**PART NO.**  
**752-2**

## DUNCAN SPINNER KNOB

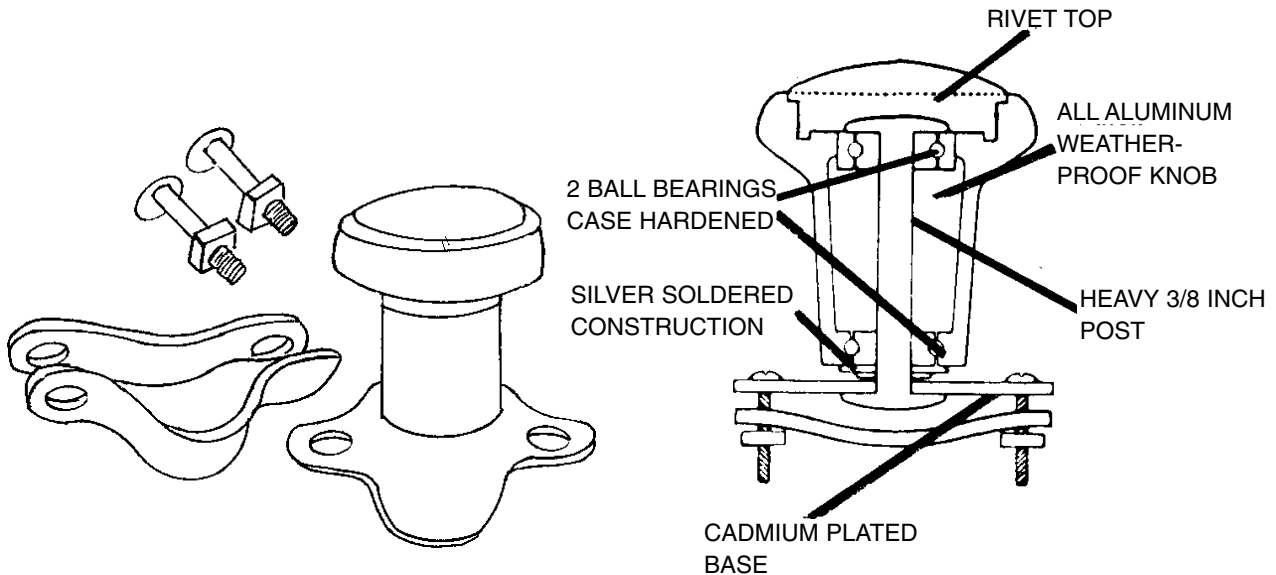

2 BALL BEARINGS SPIN FREE AND EASY  
DURABLE WEATHERPROOF POST, ALUMINUM KNOB  
FOR MITTENED HANDS, TALL SHAFT FOR SURE GRIP &  
ADDED EASE FOR POWER STEERING  
(12 PER DISPLAY BOX)

**PART NO.**  
**752-1**